

USER'S INFORMATION MANUAL

SINGLE AND MULTI-ZONE DUCTLESS SYSTEM AIR CONDITIONER OR HEAT PUMP

MODELS: 16 & 22 SEER



TABLE OF CONTENTS

GENERAL	1	GENERAL OPERATION	6
SAFETY	2	REMOTE CONTROL BATTERIES REPLACEMENT	6
DUCTLESS SYSTEM DEFINITIONS	2	EMERGENCY OPERATION	6
EQUIPMENT MODEL NUMBERS	2	MAINTENANCE	7
DUCTLESS SYSTEM OPERATION	3	INSTALLATION AND MAINTENANCE OF HEALTHY FILTER	7
TYPICAL INSTALLATION	3	TROUBLESHOOTING	7
REMOTE CONTROL OPERATION	5	LIMITED WARRANTY	9

CONTACT INFORMATION

- Go to website at www.york.com, then click on "Contact Us" and follow the instructions.
- Contact us by mail:

Johnson Controls Unitary Products
Consumer Relations
5005 York Drive
Norman, OK 73069



LX SERIES



PREMIUM SERIES



Read this manual and keep for future reference.

GENERAL

This Manual is a guide to help assist with the operation of this ductless system. It does not contain the service procedures that have to be performed by a qualified HVAC service technician.

IMPORTANT

- *Make sure you read this manual before you start operating your new ductless system.*
- *After reading this manual, if you still need more information that may not have been covered in this manual, please contact your HVAC contractor.*
- *To ensure comfort, make sure that temperature selection has been properly set at the remote control. To ensure efficient operation, do not block air intake or outlet at either the indoor or outdoor unit. Also, do not stand nor put items on top of outdoor and indoor units.*
- *If any issues with your system were to arise, please contact your HVAC contractor.*
- *Make sure your windows and doors are shut when operating your ductless system.*

NOTICE

The refrigerant inside your ductless product uses PVE oil (Polyvinyl Ether Oil) that readily absorbs moisture from the atmosphere. To limit this "hygroscopic" action, the system should remain sealed whenever possible. If a system has been open to the atmosphere for more than 4 hours, the compressor oil must be replaced. Do not break a vacuum with air and always change the driers when opening the system for component replacement. For specific handling concerns with PVE oil, contact your HVAC contractor. Failure to follow these recommendations could result in equipment damage.

SAFETY

WARNING**ELECTRICAL SHOCK, FIRE, OR EXPLOSION HAZARD.**

- This product must be installed and serviced by a qualified installer or service agency. Improper or incomplete installation, adjustment, alteration, service or maintenance could cause personal injury, loss of life, or damage to property. Installation and service must be performed by a licensed professional dealer or contractor.
- Failure to follow safety warnings exactly could result in dangerous operation, serious injury, death or property damage.
- When servicing your ductless system, your HVAC contractor must use factory supplied service and replacement parts. Failure to follow these instructions may result in property damages such as fire, personal injury or death. The manufacturer or seller cannot be responsible for the interpretation of this information, nor can it assume any liability in connection with its use.
- The power supply must be of proper amperage and conform with local codes.
- Don't cut or damage the power cords and control cords. Electric shock or fire could result. If they are damaged, immediately call your HVAC contractor to have your ductless system serviced.
- Do not operate your ductless system without the air filter installed. The air filter should be removed and cleaned periodically to assure maximum efficiency.
- If a burning smell or smoke occurs, please turn off the power supply immediately and contact your HVAC contractor. Not doing so may cause electric shock or fire.
- Do not use flammable sprays near your ductless system. They can cause a fire or explosion.
- **R410A Refrigerant High Pressure Warning!**
The units described in this manual use R410A refrigerant which operates at 50 to 70% higher pressures than R-22. Failure to use R-410A approved service equipment could result in equipment explosion which could result in death or serious injury.
- The refrigerant provided by the manufacturer complies with all the requirements of this system. When using recycled or reprocessed refrigerant, its quality has to be as good as that of a new refrigerant. It is necessary to have the recycled or reprocessed refrigerant tested by a qualified laboratory. Failure to do so could void the warranty.
- **Grounding your ductless system is required!**
Follow proper local electrical code on requirements for grounding. Failure to follow code could result in death or serious injury.
- Do not use this system if it has been in a flooded area and underwater. Call a licensed HVAC professional to inspect the system and replace controls and electrical components that have been damaged or replace the system, if determined necessary.
- Keep combustible materials at least 3 feet away from either the indoor or outdoor unit.
- Do not insert your hands, tools or any other item into the air intake or air outlet at either the indoor or outdoor unit.
- If outdoor unit is installed on a raised stand, check condition of stand occasionally to ensure its stability.

MULTI-SPLIT SYSTEM

A multi-zone system consists of a single outdoor unit and two to five indoor units. Each zone is controlled separately by a remote control (included with the indoor unit).

EQUIPMENT MODEL NUMBERS

TABLE 1:

OUTDOOR MODEL NUMBER	INDOOR MODEL NUMBER
LX 16 SEER Single Split Cooling Only Model Numbers	
DCMF09CSM42Q1	DCMF09NWM42Q1
DCMF12CSM42Q1	DCMF12NWM42Q1
DCMF18CSM42Q1	DCMF18NWM42Q1
DCMF24CSM42Q1	DCMF24NWM42Q1
LX 16 SEER Single Split Heat Pump Model Numbers	
DHMF09CSM42Q1	DHMF09NWM42Q1
DHMF12CSM42Q1	DHMF12NWM42Q1
DHMF18CSM42Q1	DHMF18NWM42Q1
DHMF24CSM42Q1	DHMF24NWM42Q1
Premium 22 SEER Single Split Cooling Only Model Numbers	
DCPM09CSM41Q1	DCPM09NWM41Q1
DCPM09CSM42Q1	DCPM09NWM42Q1
DCPM12CSM41Q1	DCPM12NWM41Q1
DCPM12CSM42Q1	DCPM12NWM42Q1
DCPM18CSM42Q1	DCPM18NWM42Q1
DCPM24CSM42Q1	DCPM24NWM42Q1
DCPM36CSM42Q1	DCPM36NWM42Q1
Premium 22 SEER Single Split Heat Pump Model Numbers	
DHPM09CSM41Q1	DHPM09NWM41Q1
DHPM09CSM42Q1	DHPM09NWM42Q1
DHPM12CSM41Q1	DHPM12NWM41Q1
DHPM12CSM42Q1	DHPM12NWM42Q1
DHPM18CSM42Q1	DHPM18NWM42Q1
DHPM24CSM42Q1	DHPM24NWM42Q1
DHPM30CSM42Q1	DHPM30NWM42Q1
DHPM36CSM42Q1	DHPM36NWM42Q1
LX 16 SEER Multi-Splits Heat Pump Outdoor Unit Model Numbers	
DHMF18CMM42Q1	\
DHMF24CMM42Q1	\
DHMF30CMM42Q1	\
DHMF36CMM42Q1	\
DHMF42CMM42Q1	\
LX 16 SEER Multi-Splits Heat Pump Indoor Unit Model Numbers	
\	DHPM09NWM42Q1
\	DHPM12NWM42Q1
\	DHPM18NWM42Q1

DUCTLESS SYSTEM DEFINITIONS

SINGLE SPLIT SYSTEM

A single split system consists of a single outdoor unit and a single indoor unit. The single split system is controlled using a remote control (included with indoor unit).

DUCTLESS SYSTEM OPERATION

MUTI-SPLITS APPLICATION ONLY

In a multi-split application, the operating mode is determined by the zone that initiates the first demand for heating or cooling. If the system is energized and a heating demand has been initiated by zone 1, an error code (E7) will be displayed on the front panel of the indoor unit of any zone trying to initiate a cooling demand. The zone 1 remote (and remotes for other zones calling for heating) must be powered off in order to allow the system operating mode to switch to the cooling mode. Once the zone initiates the cooling demand, the mode will have to be reset in the same way to allow a heating demand in another zone. This situation occurs only when there are very different requirements in two or more zones in the system.

SINGLE SPLIT AND MULTI-SPLITS APPLICATIONS

COOLING MODE OPERATION

- Cooling Mode Operation Principles** - In the cooling mode, the indoor coil absorbs the heat from the room and transfers it to the outdoor coil where it is discharged. The system cooling capacity is affected by the outdoor ambient temperature. The indoor fan operates continuously in cooling mode even when the cooling setpoint temperature is reached. The indoor unit swing louver is fixed in an upward position. The cooling operating range of the outdoor unit is typically from 5°F (-15°C) to 115°F (46°C) for small capacity systems (9K & 12K) and 14°F (-10°C) to 115°F (46°C) for large capacity systems (18+K).
- Anti-Freezing Protection in Cooling Mode** - If the unit is running in cooling mode and frost starts forming on the indoor coil, the outdoor unit compressor will stop to protect your ductless system.

HEATING OPERATION

- Heating Operation Principles** - The refrigerant flow is reversed during the heating cycle. The outdoor coil absorbs the heat from outside and transfers it to the indoor coil where it is discharged into the living space. The system heating capacity is also affected by the outdoor ambient temperature. In heating mode, the indoor blower will continue to operate for 60 seconds after the outdoor unit shuts off. The indoor unit swing louver is fixed in a downward position. The heating operating range of the outdoor unit is from 19°F (-7°C) to 75°F (24°C). In extreme low temperature conditions, it may be necessary to supplement heating using other means such as space heater, fireplace, etc.
- Auto Defrost** - When the outdoor temperature is low and/or with high humidity, frost may form on the outdoor coil, reducing the ability of the unit to transfer energy. The unit will go into Auto Defrost mode and the heating will be discontinued for 8 to 10 minutes. When the defrost cycle is complete, the system will start running in heating mode. While the outdoor unit is in defrost mode, the following occur:
 - The fan motors of the indoor and outdoor units will stop running.
 - The indoor unit indicator flashes, and moisture may flow from the outdoor unit and steam may be observed.
- Cold Air Prevention - Hot Heat Pump** - In heating mode, if the indoor coil has not achieved a certain temperature, the indoor fan will not operate for up to 3 minutes. This may occur during:
 - Initial start-up of a heating cycle
 - Immediately after completion of an Auto mode operation
 - Heating under extremely low indoor temperatures

AUTO MODE OPERATION

When AUTO mode is selected, the setpoint temperatures in heating and cooling modes are predetermined. When AUTO mode is activated, the remote control temperature setpoint and fan operation cannot be adjusted.

- AUTO Mode - Cooling Operation** - If the indoor ambient temperature is greater than 77°F (25°C), the ductless system will operate in cooling mode and will continue to run until the indoor ambient temperature reaches 75°F (24°C). At this point, the outdoor unit's compressor and outdoor fan will operate for another 60 seconds, then they will both turn off. The indoor fan will run continuously at a speed determined by the indoor ambient temperature. When the system is in AUTO mode and in cooling operation, the indoor unit swinging louver is fixed in an upward position.
- Auto Mode - Heating Operation (heat pump only)** - If the indoor ambient temperature is less than 68°F (20°C), the system will operate in heating mode and will continue to run until the indoor ambient temperature reaches 69°F (21°C). At this point, the outdoor unit's compressor and outdoor fan will operate for another 60 seconds, then they will both turn off. The indoor fan will run continuously at a speed determined by the indoor ambient temperature. When the system is in AUTO mode and in heating operation, the indoor unit swinging louver is fixed in a downward position.

FAN MODE OPERATION

When the system is set to operate in FAN mode, the indoor fan runs continuously in AUTO, low, medium or high speed. The outdoor unit is off. In AUTO fan mode, the fan speed is determined by the indoor ambient air temperature.

DRY MODE OPERATION

When the system is set to operate in DRY mode, the indoor fan runs continuously at low speed to maximize indoor air moisture removal.

TYPICAL INSTALLATION

SINGLE SPLIT

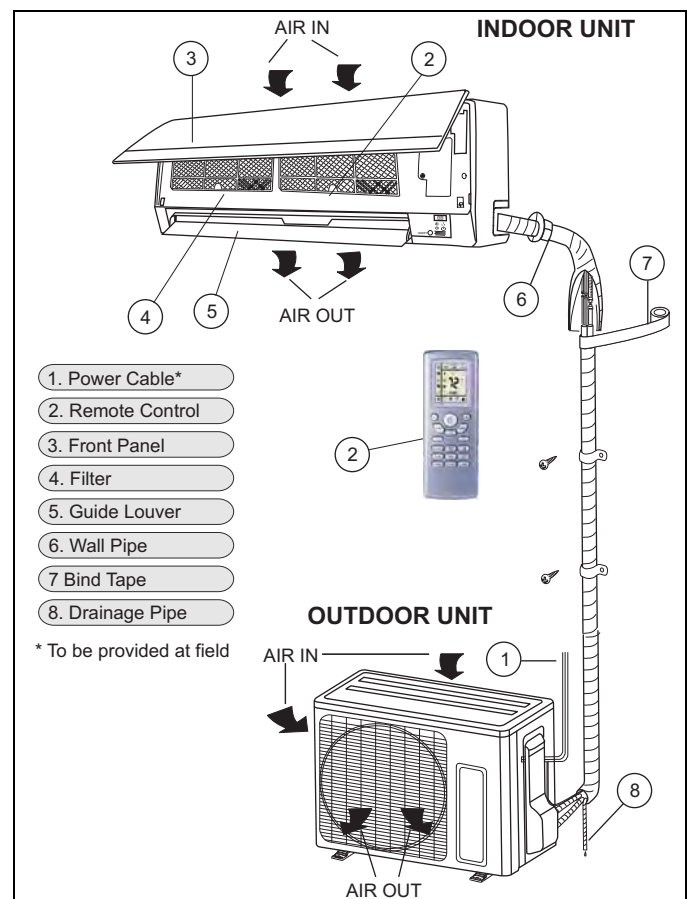

FIGURE 1: Single-Split Indoor

MULTI-SPLITS

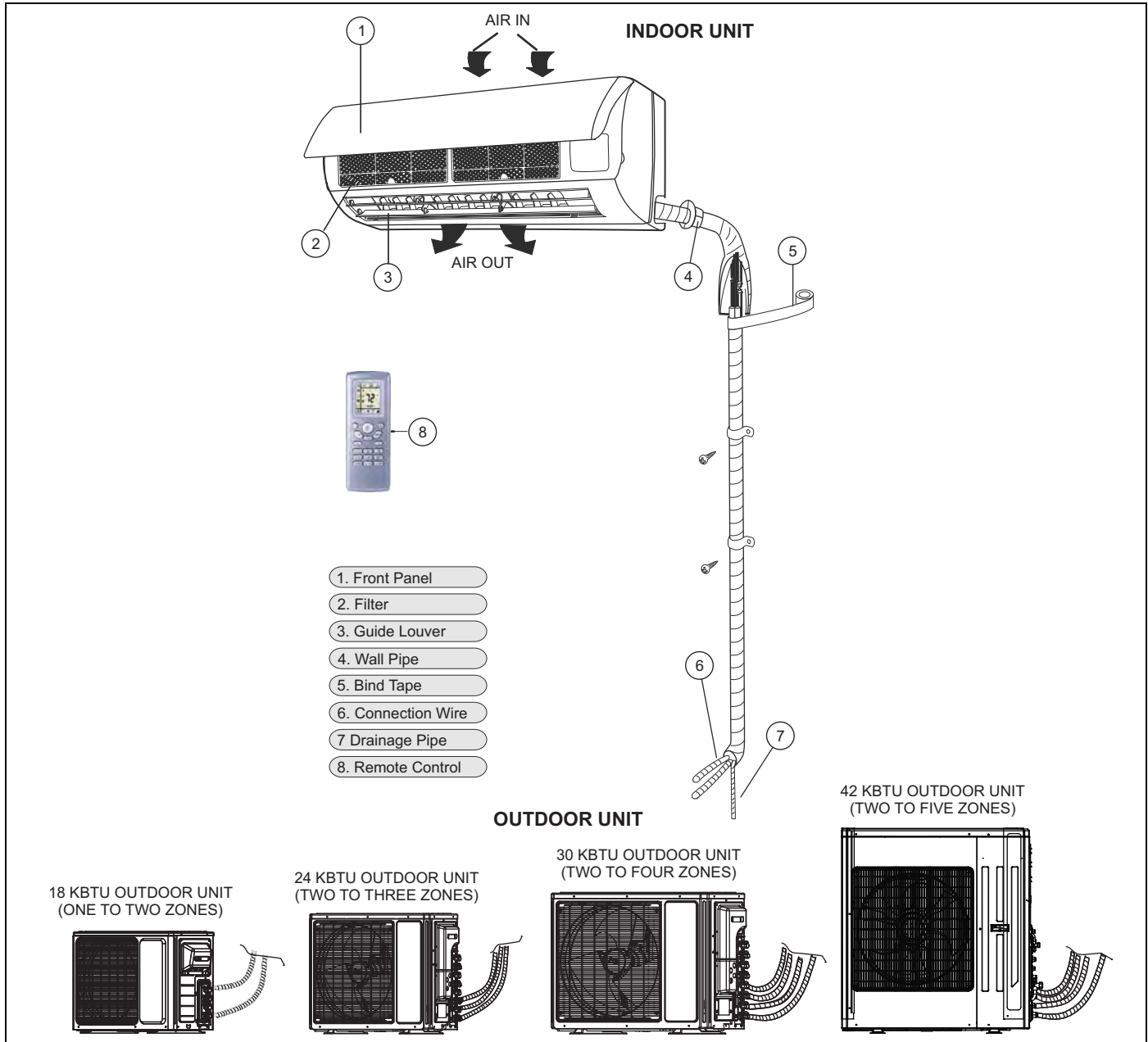

FIGURE 2: Multi-Split Units

REMOTE CONTROL OPERATION

The wireless remote control gives the homeowner the ability to operate their ductless system at the touch of a button. The indoor unit and remote control send information back and forth continuously. The remote control must be placed on a table or other surface in direct line of sight with the indoor unit infrared receiver. The remote control should not be placed in a drawer. Make sure that there are no obstructions between the indoor unit receiver and the remote control. Make sure you do not throw nor drop the remote control. The remote should never come in contact with liquids and should not be left in direct contact with the sun or any place that's very hot.



POWER BUTTON

When this button is pressed, the system will turn on. When pressed the second time, the system will turn off. When turning the system on or off, the Timer and Sleep functions (if activated) will be canceled; however the clock time will be continue to operate even when the system is off.

MODE BUTTON

Press this button to select system operating modes. AUTO mode is the default setting when the system is turn on. As MODE button is pressed, COOL, DRY, FAN and HEAT (for heat pump only) modes can be selected in this order. The selected mode is displayed on both the remote control and the indoor unit's cover panel displays. When AUTO mode is selected, the temperature will not be displayed. When in COOL mode, the default setpoint temperature is 77°F (25°C). When in HEAT mode, the default setpoint temperature is 69°F (21°C).



△ AUTO
❄ COOL
💧 DRY
🌀 FAN
☀ HEAT

¹ (Only for cooling and heating units)

+/- BUTTONS

Use plus (+) and minus (-) buttons to adjust the temperature setting up or down.

NOTICE

The temperature cannot be adjusted when the system is in AUTO mode.

FAN BUTTON

Press FAN button to select fan speed. AUTO fan is the default setting. In AUTO fan mode, the indoor fan speed is determined by the indoor ambient temperature. Press FAN button to select the desired fan setting in the following order AUTO, Low Speed, Medium Speed and High Speed. The fan speed selection is displayed at the top of the remote control display by one of these symbols.

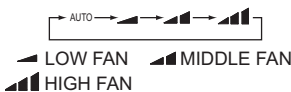

NOTICE

The fan speed is not adjustable in DRY mode operation. The low fan speed is necessary to ensure optimal humidity control.

I FEEL BUTTON

Press the I FEEL button to activate the I FEEL feature. When the I FEEL icon appears, the system will satisfy your cooling or heating (heat pump only) setpoint temperatures where the remote control is located. Press the I FEEL button again to deactivate. When I FEEL function is deactivated, the system will satisfy the cooling and heating (heat pump only) setpoint temperatures where the indoor unit is located. To use the I FEEL mode, the remote control must be placed in direct line of sight with the indoor unit infrared receiver. Make sure that there are no obstructions between the indoor unit receiver and the remote control when I FEEL feature is activated.

SWITCH FROM °C TO °F

With system OFF, press MODE and (-) buttons simultaneously to switch from Centigrade to Fahrenheit. The current selection is displayed to the right of the temperature display on the remote control.

CLOCK BUTTON

Press the CLOCK button to adjust the time displayed on the remote control. The clock icon ⌚ will flash. Press the (-) and + buttons to adjust the time up or down in one minute increments. Press and hold the button to adjust the time in 10 minute increments. Press the CLOCK button again when correct time is displayed. If no button is pushed for 5 seconds while the display is still flashing, the timer setting will not be saved.

X-FAN BUTTON

Press the X-FAN button once to initiate extended blower operation.

This function allows removal of excess moisture from the indoor unit coil after in order to prevent possible mold or bacterial growth. When the X-FAN function is activated, the indoor fan will continue to run at low speed for 10 minutes after the unit is turned off using the POWER button. The extended fan operation icon ⚙ is displayed when this feature is turned on. To deactivate, press X-FAN button again and the indoor unit fan will stop running.

LOUVER SETTING BUTTON

Press this button to set the position of the indoor unit swing louver. When this feature is turned on, icon 🌀 appears on the remote control display. Continue to press the LOUVER icon to select the desired swing angle as shown in the following sequence. When activated, the louver will start swinging right to left.



SLEEP BUTTON

Use the SLEEP button to activate or cancel the sleep function. To activate sleep function, press SLEEP button and the sleep icon should appear on the remote control display. Press SLEEP button to cancel sleep function and the sleep icon on the remote control should disappear.

In cooling mode, SLEEP function increases temperature by 2°F per hour over a two hour period from the time sleep function is activated. In heating mode, SLEEP function decreases temperature (-2°F per hour) over a two hour period from the time sleep function is activated.

Sleep function is defaulted to off when the system is turned on. If the system is turned off the Sleep function is automatically disabled.

NOTICE

The sleep function is not available in AUTO or FAN modes.

TIMER ON BUTTON

Use the TIMER ON button to initiate or cancel a single timed ON event. Use this feature to bring the system on when you return home or when you wake up in the morning. Press the TIMER ON button once. The clock icon  disappears and a time setting appears with the word ON flashing at the right. Use the (-) and + keys to adjust the time setting to the desired time for the system to begin operation. Press the TIMER ON button again to accept the setting. To make sure the function is turned on successfully, the word ON will appear to the right of the current time display. Press the TIMER ON button again if you want to cancel the timed ON event.



TIMER OFF BUTTON

Use the TIMER OFF button to initiate or cancel a single timed OFF event. Use this feature to turn the system off when you leave the house or when you go to sleep. Use the same method described above to set the desired time for the system to stop operation. To make sure the function is turned off successfully, the word OFF will appear to the right of the current time display. Press the TIMER OFF button again if you want to cancel the timed OFF event.

REMOTE LOCK

Press (-) and + buttons simultaneously to either lock or unlock the remote control buttons. When locked, the icon  is displayed.

TEMP BUTTON

Use the TEMP button to change the temperature display shown on the remote control. When the system is powered on, the current temperature setting is displayed along with this icon . Press the TEMP button one more time to display the current indoor ambient temperature, along with this icon . Press the TEMP button again to display the outdoor ambient temperature with this icon . The selected temperature will return to the display screen after 5 seconds. The TEMP button can also be used to temporarily display the indoor ambient temperature on the indoor unit display panel.

LIGHT BUTTON

Use the LIGHT button to turn the indoor unit display light on and off. When the light is on, the icon  appears on the remote control.

GENERAL OPERATION

1. To turn the system ON, press ON/OFF button, the system should start to run. (Note: when the system is powered off, the swing louver of indoor unit will close automatically).
2. Press MODE button to select the desired mode. Keep pressing until the desired mode is displayed on the remote control.
3. Pressing + or - button to set the desired temperature (temperature cannot be adjusted in AUTO mode).
4. Keep pressing FAN button to select desired fan speed. Fan speed selection is as follows: AUTO FAN, LOW, MID and HIGH.
5. Press  button, to activate the swinging louver. Press again to select a desired louver angle.
6. Press SLEEP button to initiate sleep function. Press again to deactivate.
7. Use TIMER ON and TIMER OFF buttons to schedule desired timed on and off settings
8. Use LIGHT button to set display light on or off.



9. Use X-FAN button to turn on and off extended fan operation feature in cooling and DRY modes.
10. Use TURBO button to speed up cooling or heating.
11. Use I FEEL button to control your setpoint temperature from the remote control in cooling and heating modes.

REMOTE CONTROL BATTERIES REPLACEMENT

If the remote control operation becomes erratic, remove batteries. Wait 30 seconds and reinsert batteries. If proper remote control operation is not restored, replace batteries.

The wireless remote control requires two AAA, 1.5V batteries. Follow the steps below and the illustrated graphics to replace the batteries when necessary.

1. Remove screw that secures the battery access panel to the remote control. Slide the panel in the direction of the arrow.
2. Remove the existing AAA, 1.5V batteries.
3. Replace batteries with fully charged AAA, 1.5V batteries. Make sure to pay attention to proper polarity of batteries. Remote control will not operate if batteries are improperly installed.
4. Reposition battery access panel and slide forward until panel snaps into locked position.
5. Reinsert screw.

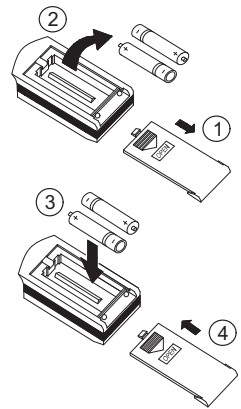

IMPORTANT

If the remote control is not going to be used for a long period of time, make sure to remove batteries to avoid damage to the control.

EMERGENCY OPERATION

If the wireless remote is lost or damaged, the system can be operated using the manual switch or code switch. The system will run in AUTO mode, and will not change the temperature setting or the fan speed.

The manual switch can be operated as follows:

- To operate the unit, press the AUTO/STOP button once and the unit will enter into AUTO RUN mode. The microcomputer will select the (COOL, HEAT, FAN) mode automatically to maintain optimum room comfort.
- To stop the unit from operating, press the AUTO/STOP button once and the unit will shut down.

The code switch can be operated as follows:

- To operate the unit, adjust the code switch to the AUTO position and the unit will enter into AUTO RUN mode. The microcomputer will select the (COOL, HEAT, FAN) mode automatically to maintain optimum room comfort.
- To stop the unit from operating, adjust the code switch to the STOP position and the unit will shut down.

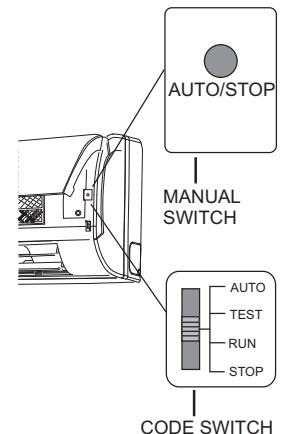

NOTICE

The **TEST** button is for the technicians' testing, which should not be used by our user.

MAINTENANCE

OUTDOOR UNIT

1. Ensure power is off before cleaning.
2. It may be necessary to wash the outdoor coil more frequently if it is exposed to substances which are corrosive or which block airflow across the coil (e.g., pet urine, cottonwood seeds, fertilizers, fluids that may contain high levels of corrosive chemicals such as salts).
3. Outdoor Coil (Sea Coast) - Moist air in ocean locations can carry salt, which is corrosive to most metal. Units that are located near the ocean require frequent inspections and maintenance. These inspections will determine the need to wash the unit including the outdoor coil. Consult your installing contractor for proper intervals/procedures for your geographic area or service contract.
4. Outdoor unit fan motor is pre-lubricated and sealed. No further lubrication is needed.
5. Visually inspect all connecting lines, joints and coils for evidence of oil leaks.
6. Check all wiring for loose connections.
7. Check for correct voltage at unit (unit operating)

INDOOR UNIT

1. Clean or change filters.
2. Check all wiring for loose connections
3. Check for correct voltage at unit (blower operating).
4. Clean coil, if necessary.
5. Check connecting lines and coils for signs of oil leaks.
6. Check condensate line and clean, if necessary.

NOTICE

The filter must be in place and the front panel must be closed any time the unit is in operation.

INSTALLATION AND MAINTENANCE OF HEALTHY FILTER (ACCESSORY)

INSTALLATION OF HEALTHY FILTER (REFER TO FIGURE 3)

- Lift up the front panel from its two ends and remove the factory supplied air filter as shown in Fig.A.
- Attach the healthy filter to the air filter as shown in Fig. B.
- Install the air filter properly as shown in Fig. C and then close the panel.

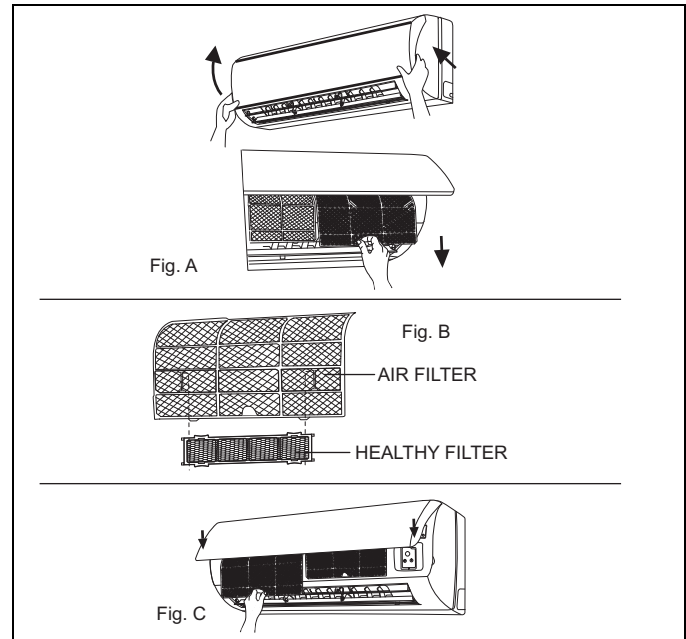

FIGURE 3: Filter Replacement

CLEANING AND MAINTENANCE

- Remove the healthy filter and clean thoroughly. Do not use a brush or any hard objects to clean the filter.
- Dry the air filter before reinstalling it.

TROUBLESHOOTING

Whenever there is a problem with the system, an error code will be displayed on the front cover of the indoor unit. If more than one error has occurred, the codes will alternate so that all codes are shown. Make note of the code (E4, F6, H4, etc.), then reset the display by pressing the ON/OFF button on the wireless remote. Press the ON/OFF button a second time to reapply power to system. If code is still displayed, disconnect and restore power at the unit disconnect switch or circuit breaker. If the problem was temporary, the code will not reappear. If the error code reappears after power has been restored, contact your HVAC contractor.

If one of the following situations occur, please unplug the unit and contact your HVAC contractor immediately:

- There is very loud sound during operation
- The strong odor coming from the indoor unit during operation
- Water is leaking into the room
- Circuit breaker trips frequently
- Water or other liquid has been splashed into the indoor unit
- There is an abnormal heat in power supply cord and power plug

If none of the above conditions exist, check the following items before calling your HVAC contractor.

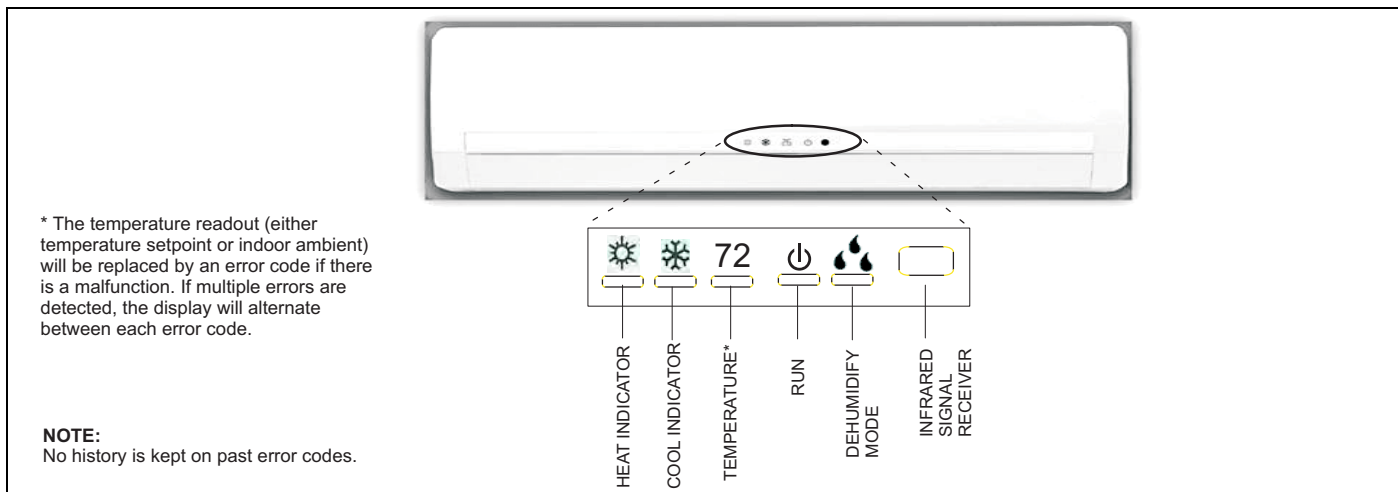

FIGURE 4: Indoor Unit Front Panel Indicators

TABLE 2:

Problem	Possible Cause
Unit does not operate immediately after being restarted.	Unit control initiates a 3 minute delay at the end of each cycle to protect the compressor from damage.
A whoosh or gurgling noise can be heard at the indoor unit.	Sometimes, the refrigerant can be heard in the indoor coil when the outdoor unit starts or stops operation. This is not a malfunction.
Mist is coming out of the indoor unit during cooling operation.	This sometimes happens when the indoor temperature and humidity are very high and the air is being cooled quickly. The mist will disappear as the indoor temperature and humidity are lowered.
A creaking or popping noise can be heard when the unit starts or stops.	The plastic components of the indoor units sometimes expand and contract when they are heated and cooled.
Unit is not operating.	Are the TIMER ON and TIMER OFF features being used incorrectly?
	Is power disconnected or has circuit breaker tripped.
	Is power shut down?
System is not cooling (or heating) efficiently.	Is temperature setting correct?
	Are either the air inlet or air outlet blocked on the outdoor or indoor unit?
	Is filter dirty?
	Is fan at low speed?
Wireless remote is not working.	Are windows and doors properly shut?
	Is remote in direct line of sight with indoor unit infrared receiver? Has the remote been damaged? Remove remote control batteries for 30 seconds, then reinsert them. Replace batteries, if necessary.
Water is leaking from indoor unit.	Indoor humidity level is very high and water is being blown from indoor coil. This will stop as humidity level is reduced.
Water is leaking from condensate line at indoor unit.	Check condensate line outside to make sure it is not obstructed.
	Check condensate line to make sure it has not been disconnected from indoor unit.
Water is leaking from the outdoor unit.	During operation in high humidity areas, condensate will form on cold outdoor refrigerant pipes.
	When heat pump is operating in defrost mode, ice will thaw from around outdoor coil and water will flow from the unit.
Clicking noise heard inside.	Sometimes, the sound of the outdoor unit fan or compressor relay can be transmitted in a way that makes it seem to be coming from the indoor unit.
Indoor fan is not working.	Heat pump units – In HEAT mode, a timed delay keeps indoor fan off for two minutes to prevent unheated air from being circulated by the indoor fan.
	Heat pump units – In HEAT mode, cold outdoor temperatures and high humidity cause frost to accumulate on the outdoor unit. When this happens, the unit will enter a defrost cycle. The indoor fan is off during the 3 – 12 minute cycle.
	In DRY mode, indoor fan operation may be stopped to avoid delivery of moist air to the room. Do not adjust temperature setting.

Limited Warranty

WARRANTY TERMS: Johnson Controls Unitary Products (hereinafter "Company") warrants this product to be free from defects in factory workmanship and material under normal use and service and will, at its option, repair or replace any parts, without charge, subject to the exclusions below, that prove to have such defects according to the terms outlined in this warranty. Company reserves the right, at its sole discretion, to provide a replacement unit in the place of repair parts, in which case the warranty period for the replacement unit is limited to the remainder of the original warranty period. Alternatively, Company may, at its option, extend a replacement allowance to be applied toward the purchase of a new unit marketed by Company. The exact amount of the allowance will be determined at the discretion of Company, based upon current market conditions, but in no case shall this allowance exceed thirty (30) percent of the original consumer purchase price of the unit excluding such items as ductwork, wiring, piping, and installation costs. The warranty period for repair or replacement parts or unit provided hereunder shall not extend beyond the warranty period stated below. Company shall have no responsibility hereunder for installation, shipping, handling, or other charges except as specifically provided herein.

This warranty covers only the equipment described by the Product Model Number and Unit Serial Number on the equipment or listed on the Warranty Registration Card, and applies only to products installed in the United States, Canada, or Puerto Rico. Tampering, altering, defacing, or removing the product serial number will serve to void this warranty. This warranty extends only to the original consumer purchaser and is nontransferable. For this warranty to apply, the product must be installed according to Company recommendations and specifications, and in accordance with all local, state, and national codes; and the product or residence must not be removed from its place of original installation. This warranty does not apply to any unit sold over the Internet, by telephone or other electronic means unless the dealer that buys or sells a unit over the Internet, by telephone or other electronic means also installs the unit. In the absence of a recorded Warranty Registration Card, the warranty period will begin upon product shipment from Company. If you are unaware of the date the warranty became effective, contact Company at (877) 874-7378 or visit www.upgproductregistration.com.

ADDITIONAL CONDITIONS FOR HEAT EXCHANGER WARRANTY: This warranty shall cover the heat exchanger (primary and/or secondary, if applicable) only if:

1. The product has not been operated with an input rate in excess of the rating plate attached to the product.
2. The product has not been allowed to operate without the use of the proper automatic limit control on the maximum warm air temperature and/or without adequate circulation.
3. The product is installed so that the combustion air is not contaminated by compounds of chlorine, fluorine, or other damaging chemicals (or vapors).
4. The product is installed such that the heat exchangers are not exposed to return air temperatures below stated ratings.

FOR PRODUCT REGISTRATION: For your benefit and protection, register your product with Company promptly after installation. This will initiate the warranty period and allow us to contact you, should it become necessary. You can register your product online at www.upgproductregistration.com or by returning the Warranty Registration Card on the back page of this packet.

Product Model Number: _____ Installation Date: _____

Unit Serial Number: _____ Installing Dealer: _____

FOR WARRANTY SERVICE OR REPAIR: Notify your Installing Dealer or a Participating Dealer, preferably in writing, as soon as possible after discovery of the problem. Be sure to include the Product Model Number, Unit Serial Number, Installation Date, and a description of the problem. You may find the Installing Dealer's name on this page or on the equipment, and you can locate Participating Dealers online at www.yorkupg.com.

If a Dealer response is not received within a reasonable amount of time, notify Company at: Johnson Controls Unitary Products, Consumer Relations, 5005 York Drive, Norman, OK 73069 or by telephone at (877) 874-7378. All warranty service or repair will be performed during regular business hours, Monday through Friday 9:00 AM - 5:00 PM. Service requests sent to Company without prior Dealer contact will be referred back to a Participating Dealer. Because this process takes time, it is in the best interest of the Consumer to contact a Participating Dealer directly.

WARRANTY PERIOD: The warranty period in years, depending on the part, is as shown in the chart below.

CONDENSING UNITS		
CONDENSING UNITS	COMPRESSOR	PARTS
ALL MODELS	6 years	2 years

MAINTENANCE: Company strongly recommends regular periodic preventive maintenance on this equipment. The person most familiar with the equipment in your HVAC system is a Participating Dealer. The Participating Dealer can ensure that your maintenance program meets the "Company Warranty" conditions, maximize the equipment efficiency, and service your unit within the mandated guidelines with regard to unlawful discharge of refrigerants into the atmosphere.

EXCLUSIONS: This warranty does not cover any:

1. Shipping, labor, or material charges or damages resulting from transportation, installation, or servicing.
2. Damage or repairs required as a consequence of mishandling, faulty installation, misapplication, abuse, improper servicing, unauthorized alteration, or improper operation.
3. Damages or failure to start resulting from improper voltage conditions, blown fuses, open circuit breakers, or other inadequacy or interruption of electrical service or fuel supply.
4. Fuses, either internal or external to the product.
5. Labor or other costs incurred for diagnosing, repairing, removing, installing, shipping, servicing, or handling of either defective parts or replacement parts.
6. Products removed from their original location for reinstallation purposes.
7. Damages resulting from accident, abuse, fire, flood, alteration, or acts of God.
8. Damages resulting from use of the product in a corrosive atmosphere.
9. Normal maintenance, or damages resulting from failure to perform normal maintenance, as outlined in the installation and servicing instructions or owner's manual.
10. Cleaning or replacement of filters, nozzles, or orifices.
11. Damages resulting from operation with inadequate supply of air or water; Damages resulting from failure to properly and regularly clean air and/or water side of condenser and evaporator.
12. Damages resulting from: (I) freezing of condenser water or condensate; (II) inadequate or interrupted water supply; (III) use of corrosive water; (IV) fouling or restriction of the water circuit by foreign material or like causes.
13. Damages caused by improper parts, components or accessories not suitable for use in or with the unit. For a list of parts that are known to be compatible please reference the equipment renewal parts list, contact a Participating Dealer for assistance, or call 1-877-874-7378.
14. Electricity or fuel costs, or increases in fuel or electric costs, for any reason including additional or unusual use of supplemental electric heat.

This warranty is in lieu of all other express warranties. All implied warranties, including the implied warranty of merchantability and fitness for a particular purpose are limited in duration to the actual warranty period applicable to the part. Some states do not allow the disclaimer of implied warranties, so the above disclaimer may not apply to you. In addition, some states do not allow limitations on how long an implied warranty lasts, so the above limitation may not apply to you. In no event, whether as a result of breach of warranty or contract, tort (including negligence), strict liability, or otherwise, shall Company be liable for special, incidental, or consequential damages or expenses, including but not limited to loss of use of the equipment or associated equipment, lost revenues or profits, cost of substitute equipment, or cost of fuel or electricity.

The above limitations shall inure to the benefit of Company's suppliers and subcontractors. The above limitation on consequential damages shall not apply to injuries to persons in the case of consumer goods. Company does not assume, or authorize any other person to assume for Company, any other liability for the sale of this product. Some states do not allow the exclusion or limitation of incidental or consequential damages, so the above limitation may not apply to you. This warranty gives you specific legal rights. You may also have other rights which vary from state to state.