



Installation & Owner's Manual

MINISPLIT HIGH WALL

AIR CONDITIONER

MODELS

HLCA-HLHA 07-36

HECB-HEHB 07-30

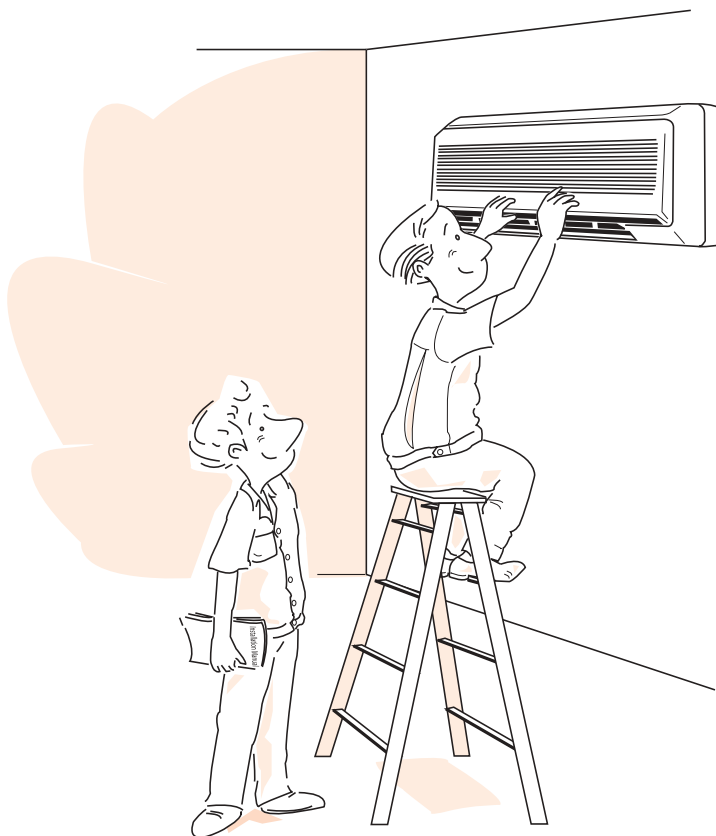

The units comply with one or more of the following marks - see unit for details.

EN035M80000-000



Please read this installation manual carefully before starting the installation. It will tell you necessary information.

Quality POLICY

We will continuously strive to satisfy our customers with consistent reliability in product, service and support through superior quality, service culture and distinctive technology.

CONTENTS

Safety Precautions	3
Part Names	4
Manual Operation	5
How the air conditioner works	5
Optimal operation	6
Preparation Before Installation	6
Installation Procedure	8
Maintenance	16
Operation tips	17
Trouble Shooting Guide	18
Technical Specification	19
Declaration of conformity	23

	R22 (50 Hz)	R22 (60 Hz)	R22 (60Hz,UL)	R407C (50 Hz)
Set	HLC _{Axx} FS _{AAAA}	HLC _{Axx} FS _{AADA}	HLC _{AXX} FS _{AAKF}	HEC _{Bxx} FS _{AAAA}
	HLH _{Axx} FS _{AAAA}	HLH _{Axx} FS _{AADA}	HLH _{AXX} FS _{AAKF}	HEH _{Bxx} FS _{AAAA}
Outdoor	HLD _{Axx} FS- _{AAA}	HLD _{Axx} FS- _{ADA}	HLD _{AXX} FS- _{AKF}	HED _{Bxx} FS- _{AAA}
	HLJ _{Axx} FS- _{AAA}	HLJ _{Axx} FS- _{ADA}	HLJ _{AXX} FS- _{AKF}	HEJ _{Bxx} FS- _{AAA}
Indoor	HLE _{Axx} FS- _{AAA}	HLE _{Axx} FS- _{ADA}	HLE _{AXX} FS- _{AKF}	HEE _{Bxx} FS- _{AAA}
	HLK _{Axx} FS- _{AAA}	HLK _{Axx} FS- _{ADA}	HLK _{AXX} FS- _{AKF}	HEK _{Bxx} FS- _{AAA}

REQUIRED TOOLS

1. Screw driver
2. Hexagonal wrench
3. Torque wrench
4. Spanner
5. Reamer
6. Hole core drill
7. Tape measure
8. Thermometer
9. Manifold Gauge
10. Gas leak detector
11. Vacuum pump
12. Pipe clamp
13. Pipe Cutter
14. Flare Tool Set
15. Electrical Circuit tester

EXTENDED PARTS

1. Refrigerant Pipe

Models	07-09	12-21	24-36
Liquid size	1/4 inch	1/4 inch	3/8 inch
Gas size	3/8 inch	1/2 inch	5/8 inch
2. Pipe Insulation Material (Polyethylene foam 9 mm thick)
3. Vinyl tape
4. Putty

SAFETY PRECAUTIONS

- Please read this installation manual carefully before starting installation of the unit.
- This air conditioning system contains refrigerant under pressure, rotating parts and electrical connection which may be dangerous and can cause injury. Installation and maintenance of this air conditioning system should only be carried out by trained and qualified personnel.
- After unpacking, please check the unit carefully for possible damage.
- Before undertaking any work on the unit, make sure that the power supply has been disconnected.

WARNING & CAUTIONS

INSTALLATION

Do not store or unpack the unit in a wet area or expose to rain or water.

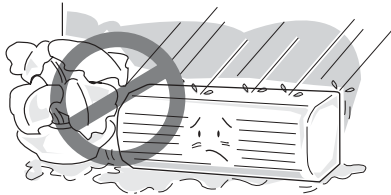

It may cause the unit to short circuit and may result electric shocks or fire.

Do not conduct installation in wet area or in the rain.

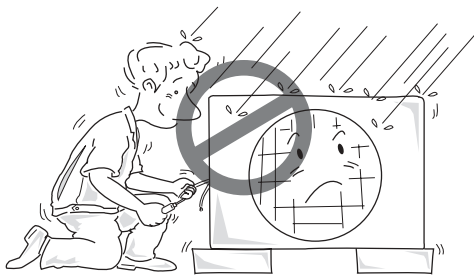

It is a high risk to cause the electrical shocks.

Do not install in a place where flammable gas may leak.

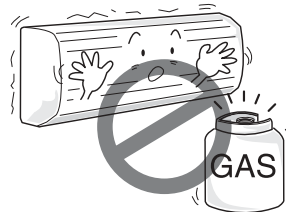

It may cause fire.

This system is designed for domestic or residential use only.



If used in certain environments, such as a manufacturing workplace, the equipment may not function efficiently.

EN

PART NAMES

INDOOR UNIT

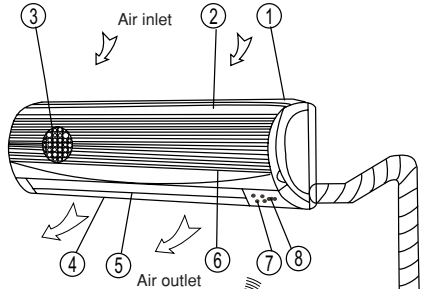

OUTDOOR UNIT

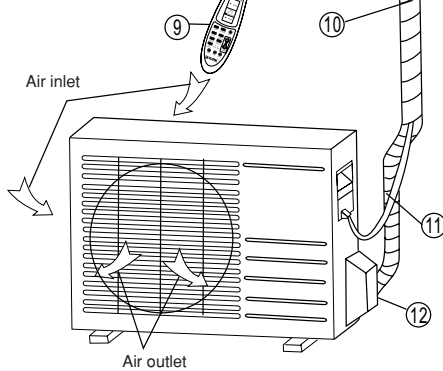

DISPLAY PANEL

NOTE

The display panel on the indoor unit would look like one of following:

Model 07-21

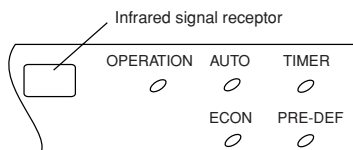
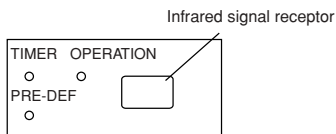

Model 24-36

Cooling/Heating

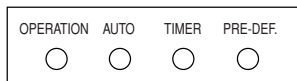

Cooling Only

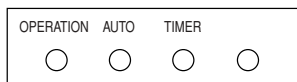

INDOOR UNIT

- ① Front panel frame
 - ② Front panel
 - ③ Air filter
 - ④ Horizontal air flow grille
 - ⑤ Vertical air flow louver
 - ⑥ Room temperature sensor
 - ⑦ Display panel
 - ⑧ Infrared signal receiver
 - ⑨ Remote controller
 - ⑩ Drain hose, refrigerant connecting pipe
 - ⑪ Connective cable
 - ⑫ Stop valve
- **Active Carbon** Electrostatic Fiber Filter (Standard)

DISPLAY PANEL

OPERATION Indicator: The indicator flashes once every second after power is on and illuminates when the air conditioner is in operation.

TIMER Indicator: The indicator illuminates when TIMER is set ON.

PRE-DEF. Indicator (For cooling & heating model only): The air conditioner starts defrosting automatically if outdoor unit frosts in heating operating. At this time, PRE.-DEF. Indicator illuminates.

AUTO Indicator: This indicator flashes when the air conditioner is in AUTO operation.

ECON Indicator: This indicator illuminates while the air conditioner is in economic operation.

NOTE

All the pictures in this manual are for explanation purpose only. They may be slightly different from the air conditioner you purchased. The actual shape shall prevail.

OPERATING TEMPERATURE

Mode	Cooling operation	Heating operation	Drying operation
Temperature			
Room temperature	17°C-32°C	0°C-30°C	17°C-32°C
Outdoor temperature	18°C-43°C (-5°C-43°C: For the models with low temperature cooling system)	-7°C-24°C	11°C-43°C

CAUTIONS

- If air conditioner is used outside of the above conditions, certain safety protection features may come into operation cause the unit to function abnormally.
- Room relative humidity less than 80%. If the air conditioner operates in excess of this figure, the surface of the air conditioner may attract condensation. Please sets the vertical air flow louver to its maximum angle (Vertically to the floor), and set HIGH fan mode.
- Optimum performance will be achieved within these operating temperature.

MANUAL OPERATION

Manual operation can be used temporarily in case you can not find the remote controller or its batteries are exhausted.

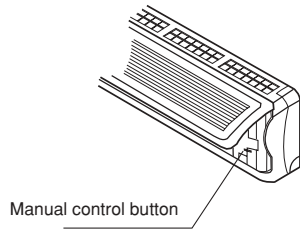
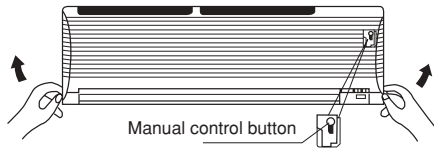

- ① Open and lift the front panel up to an angle until it remains fixed with a clicking sound.
- ② Push the button until the AUTO indicator is lit, the unit will work in forced AUTO mode.
- ③ Close the panel firmly to its original position.

CAUTIONS

- Once you push the manual button, the operation mode is shifted in an order as: AUTO, COOL, OFF.
- Push the manual button until the operation indicator flashes rapidly (five times per second), the unit now operating in forced COOL mode. This is used for testing purposes only. On forced COOL mode, the remote operation function is unavailable.
- When the OPERATION indicator goes off, the air conditioner is OFF.
- To restore the remote controller operation, use the remote controller directly.

HOW THE AIR CONDITIONER WORKS

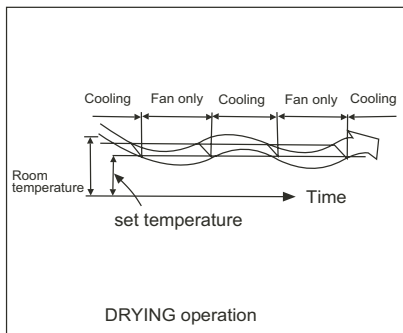
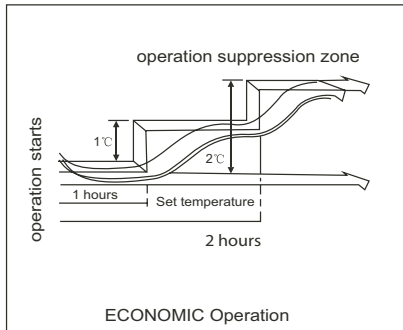

■ AUTOMATIC OPERATION

- When you set the air conditioner in AUTO mode, it will automatically select cooling, heating (cooling/heating models only), or fan only operation depending on what temperature you have selected and the room temperature.
- The air conditioner will control room temperature automatically round the temperature point set by you.
- If the AUTO mode is uncomfortable, you can select desired conditions manually.

■ ECONOMIC OPERATION

When you push ECONO button during cooling, heating (cooling only type without), or AUTO operation, the air conditioner will start following operation. The fan speed will be automatically controlled. In the operation suppression zone where capacity is kept to the minimum, overcooling is prevented by raising the temperature setting by 1°C after 1 hour and by 2°C after 2 hours of operation. The room temperature is thus regulated between the operation suppression zone and the set temperature. (It depends on the outdoor temperature.)

■ DRYING OPERATION

- The dry mode will automatically select the drying operation based on the difference between the set temperature and the actual room temperature.
- The temperature is regulated while dehumidifying by repeating turning on and off of the cooling operation or fan only. The fan speed indicator will display AUTO and low speed will be used.

OPTIMAL OPERATION

To achieve optimal performance, Please note the following:

- Adjust the air flow direction correctly so that it is not directed on people.
- Adjust the temperature to achieve the highest comfort level. Do not adjust the unit to excessive temperature levels.
- Close doors and windows on COOL or HEAT modes, or performance may be reduced.
- Use TIMER ON button on the remote controller to select a time you want to start your air conditioner.
- Do not put any object near air inlet or air outlet, as the efficiency of the air conditioner may be reduce and the air conditioner may stop running.
- Clean the air filter periodically, otherwise cooling or heating performance may be reduced.
- Do not operate unit with horizontal louver in closed position.

PREPARATION BEFORE INSTALLATION

- Before doing any work, check the interior power supply cord and the main breaker capacity are sufficient and the installation area is sufficient and complies with the requirements.
- Check that the power supply available agrees with name plate voltage.
- Electrical work, wiring and cables must be performed in compliance with national and local wiring codes and standard.
- Do not use the extension cables. In the case extended cables are needed, use the terminal block.

SELECTION OF THE LOCATION

- Select a place which provides the space around the units as shown in the diagram below.

INDOOR

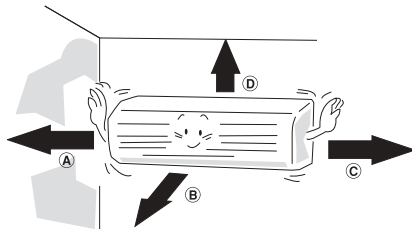

OUTDOOR

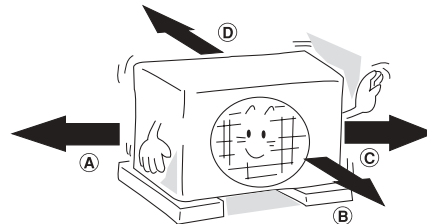

Models	07	09	12	18	21	24	30	36
A	12cm	12cm	12cm	12cm	12cm	12cm	12cm	12cm
B	70cm	70cm	70cm	70cm	70cm	70cm	70cm	70cm
C	60cm	60cm	60cm	60cm	60cm	60cm	60cm	60cm
D	15cm	15cm	15cm	15cm	15cm	15cm	15cm	15cm

Models	07	09	12	18	21	24	30	36
A	10cm	10cm	10cm	10cm	10cm	10cm	10cm	10cm
B	100cm	100cm	100cm	100cm	100cm	100cm	100cm	100cm
C	60cm	60cm	60cm	60cm	60cm	60cm	60cm	60cm
D	10cm	10cm	10cm	10cm	10cm	10cm	10cm	10cm

CAUTIONS

- Do not install in a place that cannot bear the weight of the unit.

OUTDOOR UNIT PICTURES

HLDA-HLJA 07-09, HEDB-HEJB 07-09

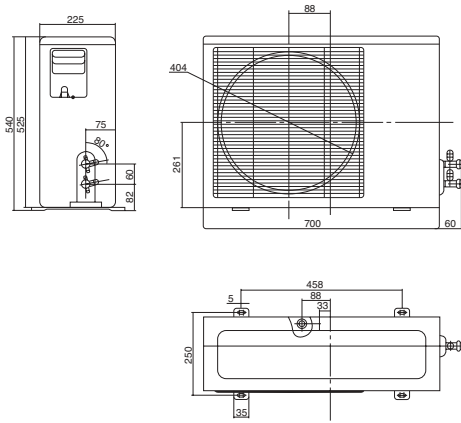

**HLDA-HLJA 21-30, HEDB-HEJB 21-30,
HLDA-HLJA 18 [220-230V, 60Hz (UL)]**

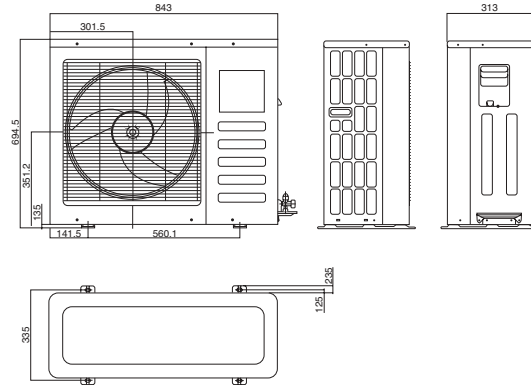

**HLDA-HLJA 12, HEDB-HEJB 12,
HLDA-HLJA 09-12 [115V, 60Hz (UL)]**

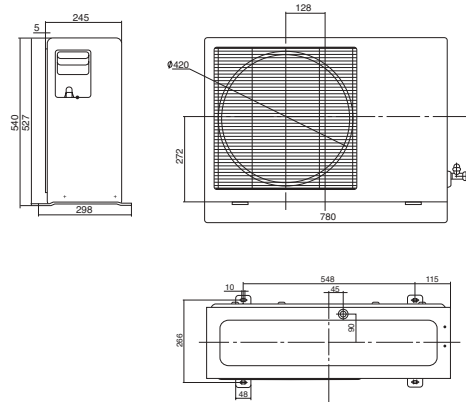

**HLDA-HLJA 36, HEDB-HEJB 36,
HLDA-HLJA 24 [220-230V, 60Hz (UL)]**

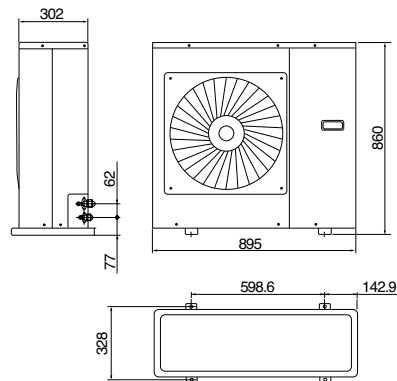

HLDA-HLJA 18, HEDB-HEJB 18

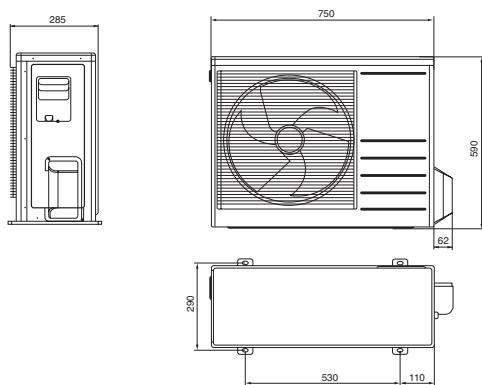

EN

PARTS INSTALLATION

Part No.	Name of part	Q'ty
1	Installation plate	1
2	Mounting screw ST3.9x25-C-H	8
3	Clip anchor	8
4	Refrigerant pipe	Parts you must purchase
	Liquid side	
	Gas side	
5	Remote controller	1
6	Remote controller holder	1
7	Seal	1
8	Drain elbow	1

NOTE: At least two of A, B, C aspect are free from blocking.

The air-conditioner can be connected only to a supply with system impedance no more than 0.26 ohm. In case necessary please consult your supply authority for system impedance information.

■ Cautions on remote controller installation

- Before installation, operate the remote controller to determine its location in a reception range.
- Keep the remote controller at least 1 m apart from the nearest TV set or stereo equipment.
- Do not install the remote controller in a place exposed to direct sunlight or close to a heating source, such as a stove.
- Note that the positive and negative poles are right positions when loading batteries.

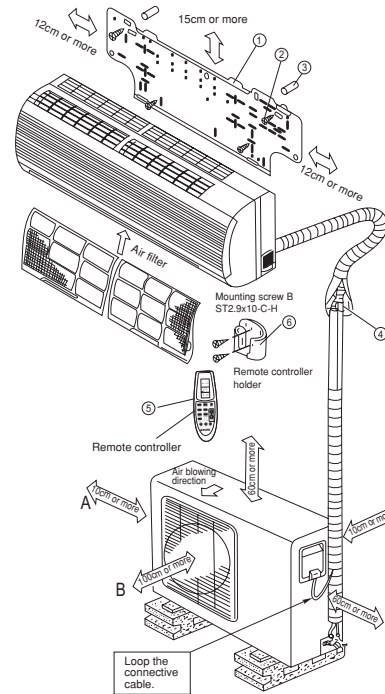

INSTALLATION PROCEDURE

INDOOR UNIT

■ Fixing

- Place the installation guide pattern on the designated installation place and mark the hole position.
- Drill a hole and mount installation plate.

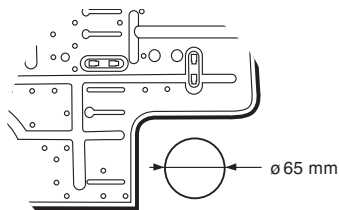

- After determining the pipe hole position drill the hole at a slight downward slant towards the outdoor side.

Note: When installing the refrigerant pipes from others side. A hole must be place to allow fall towards the outdoor unit.

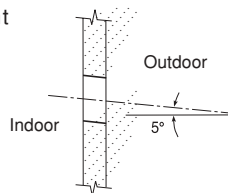

- Make 6 mm 4-6 holes, in the wall at the four corners of mounting plate (bracket) then insert appropriate mounting devices.
- Install the mounting plate using 4-6 pieces of mounting screw securely at four corners and tighten the screw completely. Do not over tighten the screws and deform the back plate.

MODEL 07-09, 12 [220-240V, 50/60Hz]

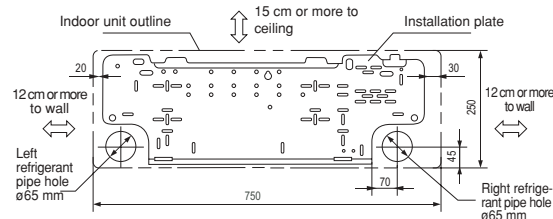

MODEL 12 [115V, 60Hz (UL)]

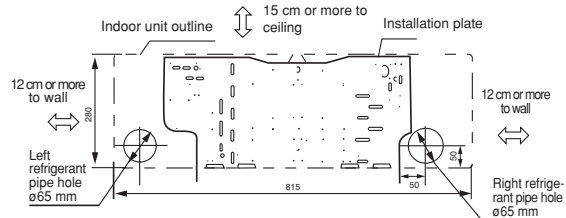



MODEL 18 [220-240V, 50/60 Hz], 21

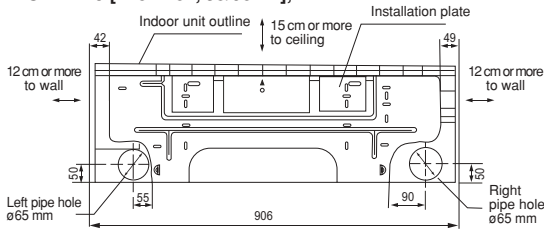

MODEL 18 [220-230V, 60Hz (UL)], 24-30

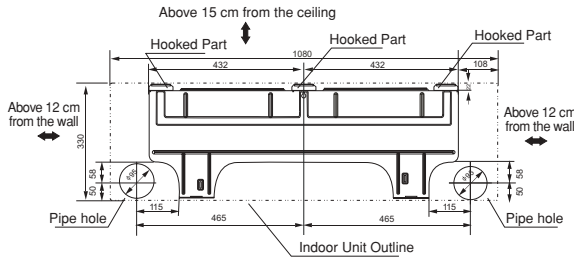

MODEL 36

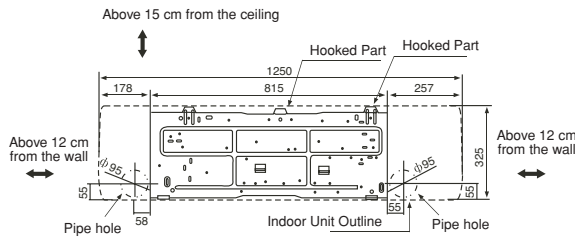

CAUTIONS

- Be careful when handling the sharp edge of the mounting plate.

Wiring

- This indoor unit is ready for connection to the outdoor unit.

CAUTIONS

- Never modify the unit by removing any of the safety guards or by passing any of the safety interlock switches.
- Connect the interconnecting cable correctly and connect the connecting cable to terminal as identified with their respective marking.
- Do not damage the conductor core or inner insulation of power supply cables and do not deform or crush the cables.

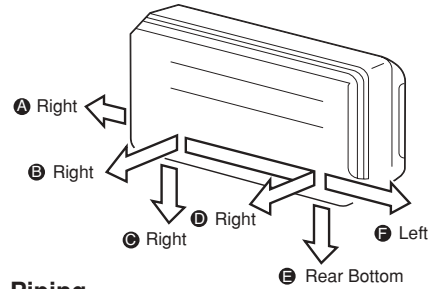

Piping

The auxiliary piping can be connected in the directions shown in the above diagram. To connect in the **D**, **E** and **F** direction, pipes will need to be extended.

CAUTIONS

- Bend pipes carefully to avoid flattening or obstructing them if the pipes are bent incorrectly, the indoor unit may be unstable on the wall.
- Carefully arrange pipes so that pipes do not stick out of the rear plate of the indoor unit.

EN

Drain hose

- Drain hose is flexible and can be routed to suit various piping arrangements. The drain line must include elbow trap (U bend). Connect a plastic condensate pipe with an internal diameter of 12 mm.

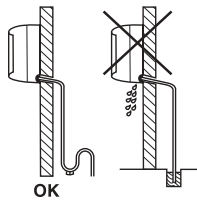

Note: Do not put the drain hose end into water.

- The drain hose can be connected to the left or the right side.

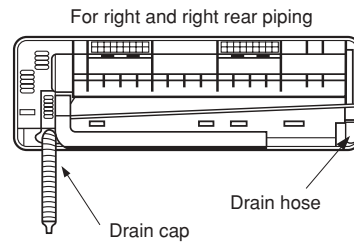
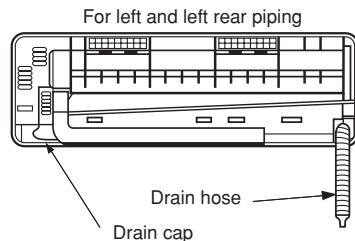

Verification of condensate water drainage:

Fill the drain pan with water and observe evacuation.

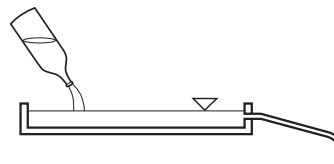

■ Indoor Unit Fixing

- Thread the indoor unit piping and cable through the hole.
- Hang the top of the unit onto the upper ridge of them in mounting plate.
- Make sure that the unit is correctly hung in place by sliding it to the left, then to the right.
- Press the bottom left and bottom right hand corners of the unit against the mounting plate until the fixing prongs click into place in the retainers provided to that effect.

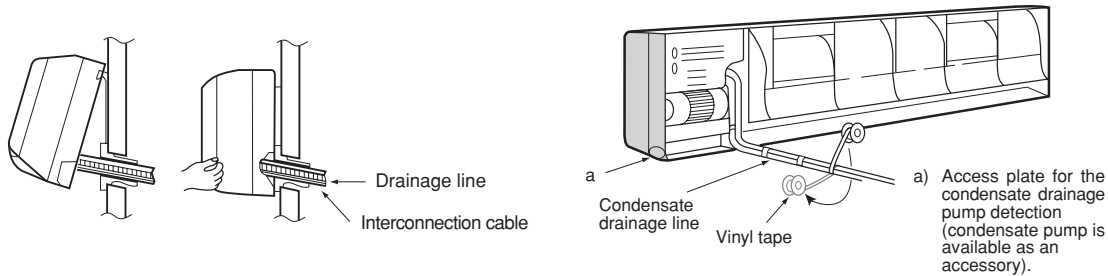

Note: The condensate evacuation line should be taped to the refrigerant lines with vinyl tape.

OUTDOOR UNIT

■ Fixing and Piping

- Piping must be performed by qualified personnel according to good refrigeration systems practices.
- Piping materials and insulation materials must be of refrigerant quality.
- Select the pipe diameters according to the size of unit and cut the pipe to design length by using pipe cutter.
- Install the flare nuts and flare the end of the pipes.
- Check that no foreign bodies are inside the piping.
- Align the central of the connecting pipes and tighten the flare nut.
- Fix piping with pipe clamps and check that any pipe vibrations cannot be transmitted to the building structure.

NOTE

- Connect the pipe correctly.
- Do not apply the excessive torque.
- Use an appropriate bending tool to form curves and avoid over-tightening the refrigerant tubes.
- To prevent heat loss, the two lines must be insulated separately.

■ Maximum Piping Length

Unit size	7	9	12	18	21	24	30	36
(m)	10	10	10	15	15	15	15	15

The suction line must have a 2% gradient up to the compressor on horizontal sections.

Where piping lengths are unusually long and include a large number of oil traps, it may be necessary to adjust to compressor charge.

Refrigerant charge to be added per extra meter of piping length when more than 7.5 meters.

Unit size	MODEL							
	7	9	12	18	21	24	30	36
g/m	15	15	15	40	40	40	40	40

■ Refrigerant piping connections (FLARE connections)

To avoid alteration of unit capacities, check that piping lengths and changes in elevation are kept to a strict minimum.

Before connecting the refrigerant lines, follow the procedures below (if pre-charged connection lines are not supplied):

- Select copper pipe diameters according to the size of unit to be installed.
- Install the refrigeration lines, checking that no foreign bodies get inside the piping.
- Install the flare connectors and flare the ends of the pipes.
- Evacuate the piping. This operation, which should last at least 15 minutes if there are large piping lengths and changes in elevation, should be followed by a leak test.



- To this effect, when the piping has been evacuated, close the pressure gauge tap, note the value on the gauge, then wait for 15 minutes. If the needle moves, there is a leak in the system. Make the necessary adjustments or repairs and repeat this procedure until the needle no longer moves.
- Open the service valves and top up the refrigerant charge if necessary.

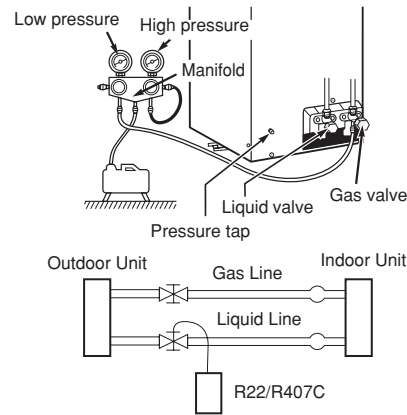
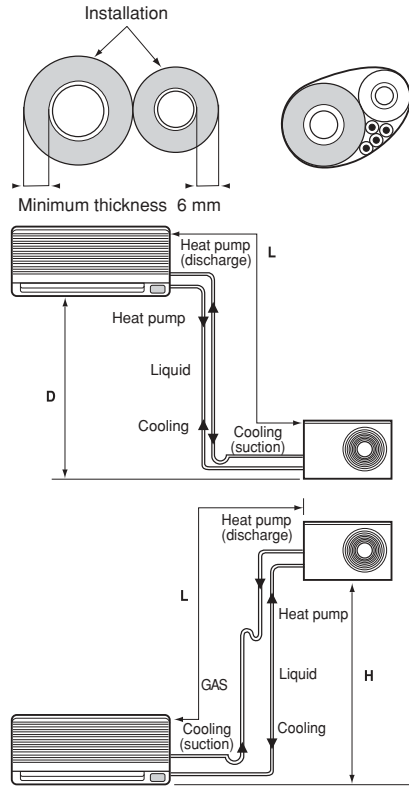

This unit is shipped complete with a charge of R22/R407C refrigerant that will be sufficient for an interconnecting piping length of 5 meters.

EN

COLD AREA RECOMMENDATION

- Outdoor heat pump unit : install the unit at least 10 cm above ground level to facilitate drainage of defrost water and prevent accumulation of ice. In effect, defrost water can cause accumulation of ice under the unit during subfreezing outdoor temperatures.
- In areas with heavy snowfall it is best to install the unit on wall supports.
- In some regions. It is necessary to heat the bottom of the condensate drainage pan and the condensate drainage piping to avoid ice formation, and resulting ice build-up in the fan compartment (heater strip must be at least 25 W/m).

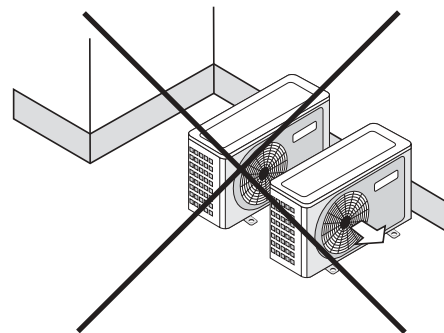
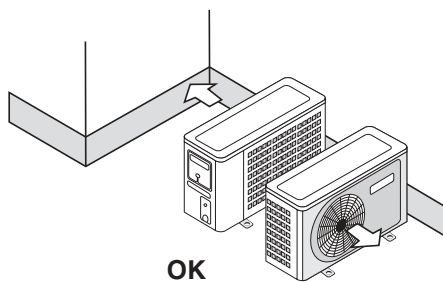

■ Wiring

Prepare the power source for exclusive with the air conditioner.

The supply voltage must comply with the rated voltage of the air conditioner: The plug socket shall be accessible after installation.

Remark: All the wiring must be based on the wiring nameplate which shown on the model.

CAUTIONS

- Perform the wiring with sufficient capacity. Installation places legally require a short circuit isolator to be attached to prevent electrical shock.
- Do not extend the power cable code by cutting.
- Power voltage should in the range of 90%~110% of rated voltage.
- The plug of the air conditioner takes a grounding leg, so clients should use a grounding socket so that the air conditioner can be grounded efficiently.
- If the power cord is damaged, replacement should be conducted by qualified technician or a serviceman.

NOTE Remark per EMC Directive 89/336/EEC

For to prevent flicker impressions during the start of the compressor (technical process), following installation conditions do apply.

1. The power connection for the air conditioner has to be done at the main power distribution.
The distribution has to be of an low impedance, normally the required impedance reaches at a 32 A fusing point.
2. No other equipment has to be connected with this power line..
3. For detailed installation acceptance, please refer to your contract with the power supplier if restrictions do apply for products like washing machines, air conditioner or electrical ovens.
4. For power details of the air conditioner, refer to the rating plate of the product.
5. For any question contact your local dealer.

CAUTIONS

- Never modify the unit by removing any of the safety guards or by bypassing any of the safety interlock switches.
- Connect the connecting cable correctly and connect the connecting cable to terminal as identified with their respective marks.
- Do not scratch the conductive core & inner insulator of power supply cables and do not deform or smash on the surface of cables.

■ Electrical Connections

All electrical wiring and connections must comply with local codes and standards. Power supply cord and interconnection cord used must not be lighter than Polychloroprene sheeted cord (245 IEC 57 or H05RN-F).

Disconnecting device must have a contact separation of at least 3 mm.

Model : 07-21 (Cooling only)

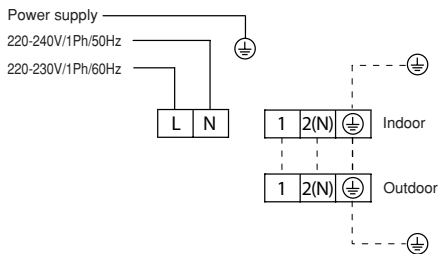

Model : 07-21 (Cooling and Heating)

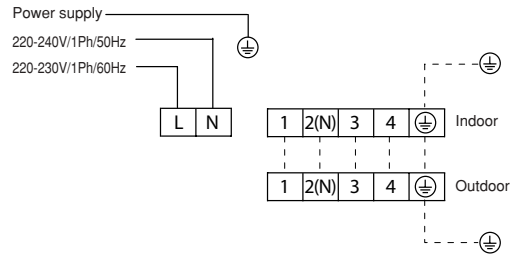

Model : 09-12 115V, 60Hz (UL) (Cooling only)

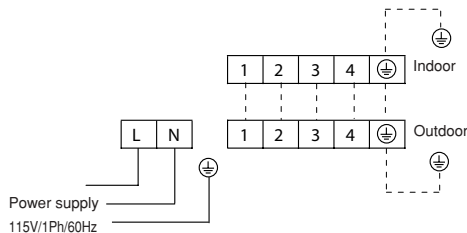

Model : 18-24 220-230V, 60Hz (UL) (Cooling only)

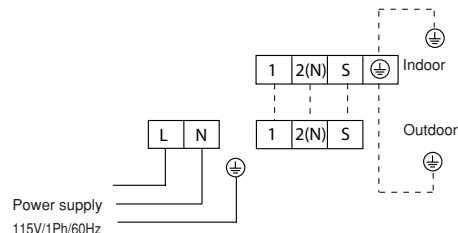



Model : 24-30, 1Ph (Cooling only)

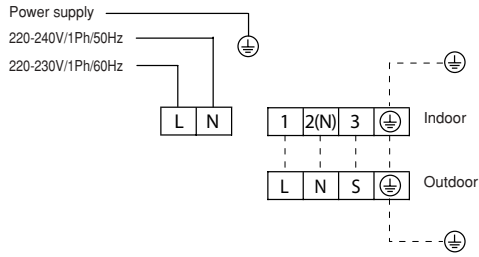

Model : 24-30, 1Ph (Cooling and Heating)

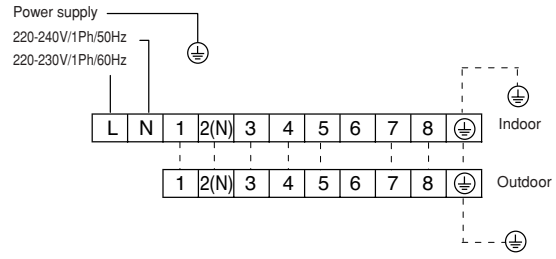

Model : 30, 3Ph (Cooling only)

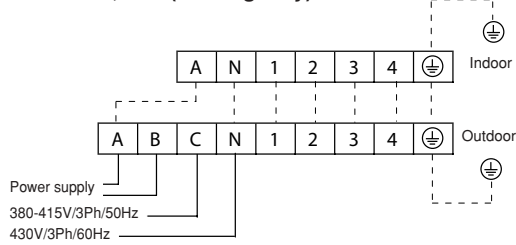

Model : 30, 3Ph (Cooling and Heating)

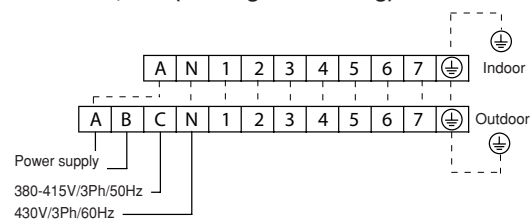

For correct installation, a proper ground connection must be made for unit.

■ Wiring Connection

Model : 07-21

Indoor

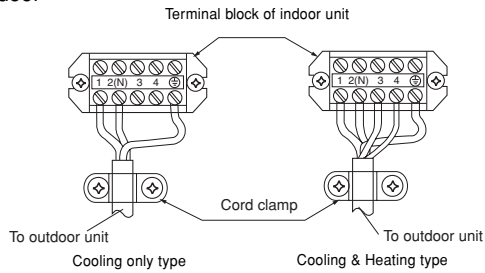

Outdoor

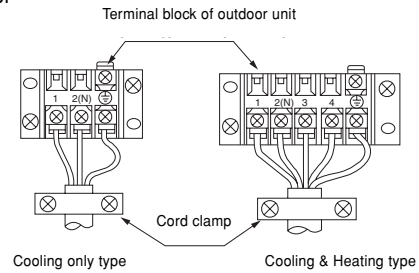

Model : 09-12 [115V, 60Hz (UL)]

Indoor

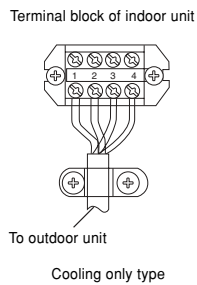

Outdoor

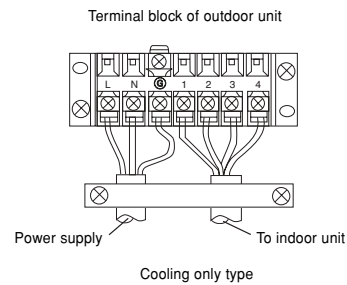

EN



Model : 24-30

Indoor

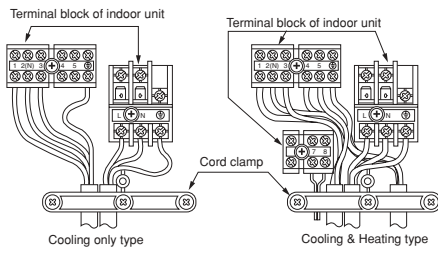

Outdoor

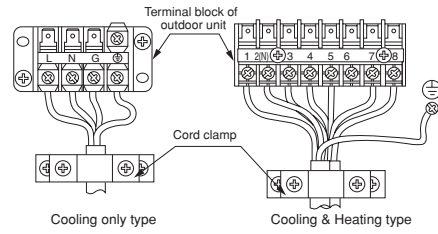

Model : 18, 24 [220-230V, 60Hz (UL)]

Indoor

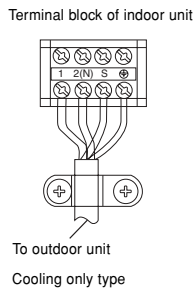

Outdoor

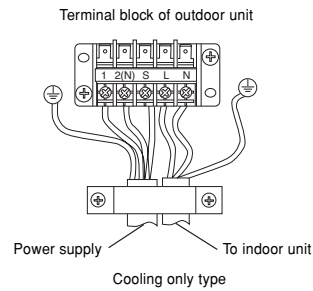

Model : 30, 3 Ph

Indoor

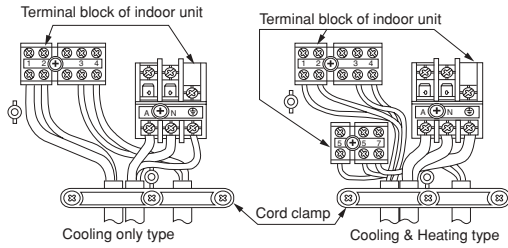

Outdoor

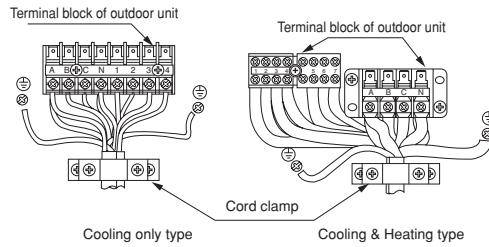

Model : 36

Indoor

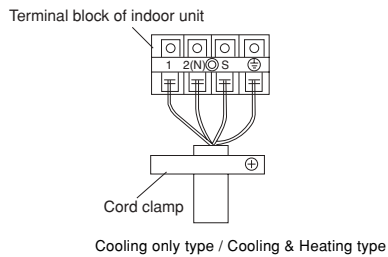

Outdoor

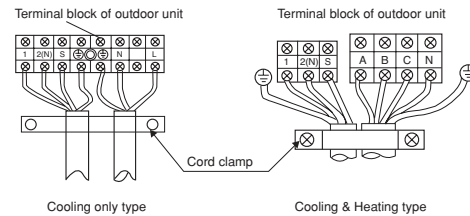

■ Electrical Work

Model	Power Source	Power Switch and Fuse rating	Wiring size
7000-9000 Btu/h	220-240V ~ 50Hz	10A	≥ 1.0 mm ²
	220-240V ~ 60Hz		
	115V~60Hz (UL)		
12000 Btu/h	220-240V ~ 50Hz	15A	≥ 1.5 mm ²
	220-240V ~ 60Hz		
	115V~60Hz (UL)		
18000-21000 Btu/h	220-240V ~ 50Hz	20A	2.5 mm ²
	220-240V ~ 60Hz		≥ 1.5 mm ²
	220-230V~60Hz (UL)		≥ 2.5 mm ²
24000 Btu/h	220-240V ~ 50Hz	32/20A	≥ 2.5 mm ²
	220-240V ~ 60Hz		
	220-230V~60Hz (UL)		
28000-30000 Btu/h	220-240V ~ 50Hz	32/25A	≥ 2.5 mm ²
	220-240V ~ 60Hz		
	380-420V 3N ~ 60Hz		
36000 Btu/h	220-240V ~ 50Hz	45/30A	≥ 3.3 mm ²
	380-420V 3N ~ 60Hz	25/15A	≥ 2.5 mm ²

NOTE

The supply voltage must be consistent with the rate voltage of the air conditioner.

■ Defrosting operation (Available for heating only).

- Condition to start defrosting: Units will switch to defrosting mode when either of the following conditions is met.
 - Unit has been running under $T_3 < 0^\circ\text{C}$ for 40 minutes and $T_3 < -3^\circ\text{C}$ for 3 minutes.
 - Unit has been running at high temperature protection mode* for 90 minutes. (*High temperature protection mode: when coil temperature of indoor unit reaches 55°C , outdoor unit will turn off external unit fan but still keep compressor running).

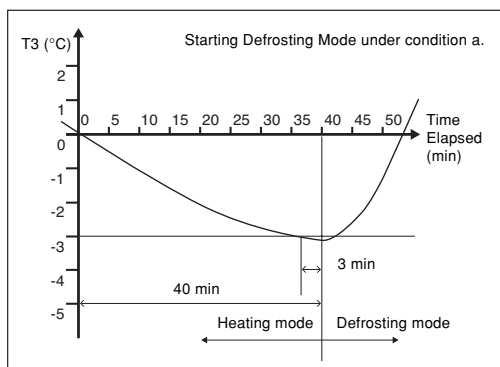

- Condition to stop defrosting: Units will switch back to heating mode when either of the following conditions is met.
 - Unit has been running at defrosting mode for 10 minutes.
 - $T_3 > 20^\circ\text{C}$

Remark: T_3 is coil temperature of outdoor units.

EN

MAINTENANCE

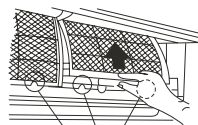
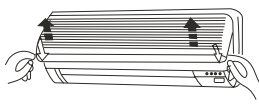

Filter Handle

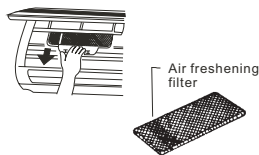
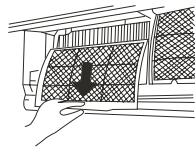

①

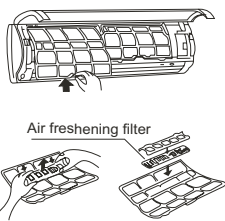

②

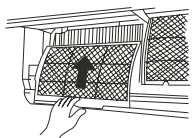

⚠ WARNING

It is necessary to stop the air conditioner and disconnect the power supply before cleaning.

■ Cleaning the indoor unit and remote controller

⚠ CAUTION

- Use a dry cloth to wipe the indoor unit and remote controller.
- A cloth dampened with cold water may be used on the indoor unit if it is very dirty.
- The front panel of the indoor unit can be removed and cleaned with water. Then wipe it with a dry cloth.
- Do not use a chemically treated cloth or duster to clean the unit.
- Do not use benzene, thinner, polishing powder, or similar solvents for cleaning. These may cause the plastic surface to crack or deform.

■ Cleaning the air filter

A clogged air filter reduces the cooling efficiency of this unit. Please clean the filter once every 2 weeks.

1. Lift the indoor unit panel up to an angle until it stops with a clicking sound.
2. Take hold of the handle of the air filter and lift it up slightly to take it out from the filter holder, then pull it downwards.
3. Remove the AIR FILTER from the indoor unit.
 - Clean the AIR FILTER once two weeks.
 - Clean the AIR FILTER with a vacuum cleaner or water, then dry it up in cool place.
4. Remove the air freshening filter from its support frame (The installation and removing method of the air freshening filter is different depending on the models, see the pictures marked ① and ② on the left.)
 - Clean the air freshening filter at least once a month, and replace it every 4-5 months.
 - Clean it with vacuum cleaner, then dry it in cool place.
5. Install the air freshening filter back into position.
6. Insert the upper portion of air filter back into the unit taking care that the left and right edges line up correctly and place filter into position.

■ Maintenance

If you plan to idle the unit for a long time, perform the following:

- (1) Operate the fan for about half a day to dry the inside of the unit.
- (2) Stop the air conditioner and disconnect power. Remove the batteries from the remote controller.
- (3) The outdoor unit requires periodic maintenance and cleaning. Do not attempt to do this yourself. Contact your dealer or servicer.

■ Checks before operation

- Check that the wiring is not broken off or disconnected.
- Check that the air filter is installed.
- Check if the air outlet or inlet is blocked after the air conditioner has not been used for a long time.

⚠ CAUTION

- Do not touch the metal parts of the unit when removing the filter. Injuries can occur when handling sharp metal edges.
- Do not use water to clean inside the air conditioner. Exposure to water can destroy the insulation, leading to possible electric shock.
- When cleaning the unit, first make sure that the power and circuit breaker are turned off.

OPERATION TIPS

The following events may occur during normal operation.

1. Protection of the air conditioner.

Compressor protection

- The compressor cannot restart for 3 minutes after it stops.
Anti-cold air (Cooling and heating models only)
- The unit is designed not to blow cold air on HEAT mode, when the indoor heat exchanger is in one of the following three situations and the set temperature has not been reached.
 - A) When heating has just starting.
 - B) Defrosting.
 - C) Low temperature heating.
- The indoor or outdoor fan stop running when defrosting (Cooling and heating models only).
Defrosting (Cooling and heating models only)
- Frost may be generated on the outdoor unit during heat cycle when outdoor temperature is low and humidity is high resulting in lower heating efficiency of the air conditioner.
- During this condition air conditioner will stop heating operation and start defrosting automatically.
- The time to defrost may vary from 4 to 10 minutes according to the outdoor temperature and the amount of frost buildup on the outdoor unit.

2. A white mist coming out from the indoor unit.

- A white mist may generate due to a large temperature difference between air inlet and air outlet on COOL mode in an indoor environment that has a high relative humidity.
- A white mist may generate due to moisture generated from defrosting process when the air conditioner restarts in HEAT mode operation after defrosting.

3. Low noise of the air conditioner.

- You may hear a low hissing sound when the compressor is running or has just stopped running.
This sound is the sound of the refrigerant flowing or coming to a stop.
- You can also hear a low "squeak" sound when the compressor is running or has just stopped running. This is caused by heat expansion and cold contraction of the plastic parts in the unit when the temperature is changing.
- A noise may be heard due to louver restoring to its original position when power is first turned on.

4. Dust in blown out from the indoor unit.

This is a normal condition when the air conditioner has not been used for a long time or during first use of the unit.

5. A peculiar smell come out from the indoor unit.

This is caused by the indoor unit giving off smells permeated from building material, from furniture, or smoke.

6. The air conditioner turns to FAN only mode from COOL or HEAT (For cooling and heating models only) mode.

When indoor temperature reaches the temperature setting on air conditioner, the compressor will stop automatically, and the air conditioner turns to FAN only mode. The compressor will start again when the indoor temperature rises on COOL mode or falls on HEAT mode (For cooling and heating models only) to the set point.

7. Dripping water may generate on the surface of the indoor unit when cooling in a high relatively humidity (relative humidity higher than 80%). Adjust the horizontal louver to the maximum air outlet position and select HIGH fan speed.

8. Heating mode (For cooling and heating models only)

The air conditioner draws in heat from the outdoor unit and releases it via the indoor unit during heating operation. When the outdoor temperature falls, heat drawn in by the air conditioner decreases accordingly. At the same time, heat loading of the air conditioner increases due to larger difference between indoor and outdoor temperature. If a comfortable temperature cannot be achieved by the air conditioner, we suggest you use a supplementary heating device.

9. Auto-restart function

Power failure during operation will stop the unit completely.

For the unit without Auto-restart feature, when the power restores, the OPERATION indicator on the indoor unit starts flashing. To restart the operation, push the ON/OFF button on the remote controller. For the unit with Auto-restart feature, when the power restores, the unit restarts automatically with all the previous settings preserved by the memory function.

10. Lightning or a car wireless telephone operating nearby may cause the unit to malfunction.

Disconnect the unit with power and then re-connect the unit with power again. Push the ON/OFF button on the remote controller to restart operation.

EN

TROUBLE SHOOTING GUIDE

Problem	Probable cause	Remedy
A. The air conditioner does not run.	<ol style="list-style-type: none"> 1. Power Failure. 2. Fuse blown or circuit breaker open. 3. Voltage is too low. 4. Faulty contactor or relay. 5. Electrical connections loose. 6. Thermostat adjustment too low (in heating mode) or too high (in cooling mode) 7. Faulty Capacitor 8. Incorrect wiring, terminal loose 9. Pressure switch tripped 	<ol style="list-style-type: none"> 1. Wait for Power resume. 2. Replace the fuse or reset the breaker. 3. Find the cause and fix it. 4. Replace the faulty component. 5. Retighten the connection. 6. Check Thermostat setting. 7. Find the cause then replace Capacitor. 8. Check and retighten. 9. Find the cause before reset.
B. The outdoor fan runs but the compressor will not start.	<ol style="list-style-type: none"> 1. Motor winding cut or grounded. 2. Faulty Capacitor. 	<ol style="list-style-type: none"> 1. Check the wiring and the compressor winding resistance. 2. Find the cause then replace Capacitor.
C. There is insufficient heating or cooling.	<ol style="list-style-type: none"> 1. There is a gas leak. 2. Liquid and gas line insulated together. 3. The room was probably very hot (cool) when you started the system. 	<ol style="list-style-type: none"> 1. Remove charge, repair, evacuate and recharge. 2. Insulate them separately. 3. Wait while unit has enough time to cool the room.
D. The compressor run continuously.	<ol style="list-style-type: none"> 1. Thermostat adjustment too low (in heating mode) or too high (in cooling mode) 2. Faulty fan. 3. Refrigerant charge too low, leak. 4. Air or incondensables in refrigerant circuit. 	<ol style="list-style-type: none"> 1. Check Thermostat setting. 2. Check condenser air circulation. 3. Find leak, repair and recharge. 4. Remove charge, evacuate and recharge.
E. The compressor starts but shuts down quickly.	<ol style="list-style-type: none"> 1. Too much or too little refrigerant. 2. Faulty compressor. 3. Air or incondensables in refrigerant circuit. 4. Changeover valve damaged or blocked open (heat pump unit) 	<ol style="list-style-type: none"> 1. Remove charge, evacuate and recharge. 2. Determine the cause and replace compressor. 3. Remove charge, evacuate and recharge. 4. Replace it.
F. Clicking sound is heard from the air conditioner.	In heating or cooling operation any plastic parts may expand or shrink due to a sudden temperature change in this event, a clicking sound may occur.	In heating or cooling operation any plastic parts may expand or shrink due to a sudden temperature change in this event, a clicking sound may occur.

TECHNICAL SPECIFICATION

Technical Specifications : Ultra R22 - 50 Hz

Models	Indoor Unit		HLEA-HLKA																			
	HLEA07	HLKA07	HLEA09	HLKA09	HLEA12	HLKA12	HLEA18	HLKA18	HLEA21	HLKA21	HLEA24	HLKA24	HLEA30	HLKA30	HLEA36	HLKA36	HLEA36	HLKA36				
Power Supply	Outdoor Unit		HLDA-HLJA																			
	HLDA07	HLJA07	HLDA09	HLJA09	HLDA12	HLJA12	HLDA18	HLJA18	HLDA21	HLJA21	HLDA24	HLJA24	HLDA30	HLJA30	HLDA30	HLJA30	HLDA36	HLJA36	HLDA36	HLJA36		
	V/Ph/Hz		220-240/1/50 or 380-415/3/50																			
	Ph		1	1	1	1	1	1	1	1	1	1	3	1	3							
Power Consumption	W		760	1000	1230	1930	1920	2300	2750	3200	3000	4120										
Running Current	A		3.6	4.5	5.7	9.1	9	10.5	12.5	15	5.3	18.6	6.5									
Refrigerant Type			R22																			
Refrigerant Charge			580	620	580	700	730	860	1110	1370	1220	1740	1850	1900	2250	2450	2250	2450	2400	2450	2400	2450
Noise level	Indoor		dB(A)																			
	Outdoor		35/33/31	40/37/33	41/38/34	41/38/35	41/37/33	43/40/37	50/47/44	50/47/43	49/46/42											
			52	53	52	54	54	≤58	≤60	59												
Indoor Unit	Power Supply		220-240/1/50 or 380-415/3/50																			
	A		1	1	1	1	1	1	1	1	1	1	3	1	3							
	Fan	Air flow (Hi/Mi/Lo)	m³/h	380/350/320	450/420/390	550/500/460	750/710/650	800/760/700	1050/950/850	1150/1050/950	1350/1200/1050											
		Input Power	W	36.5			53			65/63/60			68/65/62			72/67/63			85/80/77			
		Running Current	A	0.17			0.26			0.317			0.38			0.38			0.38			
	Dimension	Height	mm	250			286			330			325			325			325			
		Width	mm	750			906			1080			1250			1250			1250			
		Depth	mm	188			235			222			230			230			230			
	Weight	kg	8.5			13.5			17			18			18			18				
	System Operation Control		Wireless Control with LCD Display																			
Outdoor Unit	Power Supply		220-240/1/50 or 380-415/3/50																			
	Ph		1	1	1	1	1	1	1	1	1	1	3	1	3							
	Compressor	Qty	1	1	1	1	1	1	1	1	1	1	1	1	1	1	1	1	1	1		
		Compressor Type	Rotary						Scroll													
	Dimension	Height	mm	535			540			590			695			860						
		Width	mm	700			780			760			845			895						
		Depth	mm	235			250			285			335			330						
	Weight	kg	27	28	29	30	34	36	43	44	52	55	58	60	67	69	67	69	80	82	80	82
	Piping	Type		Flare + Nut																		
		Pipe Size	Suction	inch	3/8			1/2			5/8			5/8			5/8					
		Liquid	inch	1/4			1/4			3/8			3/8			3/8						

Remark: The above design and specifications are subject to change without prior notice for product improvement.

TECHNICAL SPECIFICATION

Technical Specifications : Ultra R22 - 60 Hz

Models	Indoor		HLEA-HLKA														
	Unit		HLEA07	HLKA07	HLEA09	HLKA09	HLEA12	HLKA12	HLEA18	HLKA18	HLEA21	HLKA21	HLEA24	HLKA24	HLEA30	HLKA30	
Power Supply	Outdoor		HLDA-HLJA														
	Unit		HLDA07	HLJA07	HLDA09	HLJA09	HLDA12	HLJA12	HLDA18	HLJA18	HLDA21	HLJA21	HLDA24	HLJA24	HLDA30	HLJA30	
	V/Ph/Hz		220-230/1/60														
	Ph		1		1		1		1		1		1		1		
Power Consumption	W		800		1000		1330		1950		2400		2700		3200		
Running Current	A		3.7		4.6		6.1		8.9		11		12.5		15		
Refrigerant Type			R22														
Refrigerant Charge			530	590	630	650	780	1280	1020	1320	1280	2000	2150	2350	2250	2450	
Noise level	Indoor	dB(A)	39/36/32		40/37/33		41/38/34		44/39/35		46/42/37		48/45/42		50/47/44		
	Outdoor		52		52 53		56		56		58		≤58		≤60		
Indoor Unit	Power Supply	V/Ph/Hz	220-230/1/60														
		Ph	1		1		1		1		1		1		1		
	Fan	Air flow (Hi/Mi/Lo)	m³/h	380/350/320		450/420/390		550/500/460		750/710/650		800/760/700		1050/950/850		1150/1060/960	
		Input Power	W	31W / 1350 RPM													
		Running Current	A	0.14						0.295				0.356			
	Dimension	Height	mm	250						286				330			
		Width	mm	750						906				1080			
		Depth	mm	188						235				222			
	Weight	kg	8.5						13.5				17				
	System Operation Control			Wireless Control with LCD Display													
Outdoor Unit	Power Supply	V/Ph/Hz	220-230/1/60														
		Ph	1		1		1		1		1		1		1		
	Compressor	Qty		1		1		1		1		1		1		1	
		Compressor Type		Rotary										Scroll			
	Dimension	Height	mm	535		540		590		695							
		Width	mm	700		780		760		845							
		Depth	mm	235		250		285		335							
	Weight	kg	27	28	32	30	34	36	43	44	50	55	58	60	67	69	
	Piping	Type		Flare + Nut													
		Pipe Size	Suction	inch	3/8				1/2				5/8				
Liquid			inch	1/4				1/4				3/8					

Remark: The above design and specifications are subject to change without prior notice for product improvement.

TECHNICAL SPECIFICATION

Technical Specifications : Ultra R22 - 60Hz (UL)

Models	Indoor Unit		HLEA-HLKA			
			HLEA09	HLEA12	HLEA18	HLEA24
Power Supply	Outdoor Unit		HLDA-HLJA			
			HLDA09	HLDA12	HLDA18	HLDA24
Power Supply	V/Ph/Hz		115/1/60		220-230/1/60	
	Ph		1	1	1	1
Power Consumption	W		850	1200	1760	2600
Running Current	A		7.4	5.7	9.1	12.5
Refrigerant Type		R22				
Refrigerant Charge		930	1070	1470	2350	
Noise level	Indoor		40/38/35		46/43/40	
	Outdoor		54		57	
Power Supply	V/Ph/Hz		115/1/60		220-230/1/60	
	Ph		1	1	1	1
Air flow (Hi/Mi/Lo)	m³/h		520/460/410		680/540/460	
	m³/h		1050/920/800		100/1000/880	
Input Power	W		23	23	72	74
Running Current	A		0.1	0.1	0.33	0.34
Dimension	Height		250	280	330	330
	Width		750	815	1080	1080
Dimension	Depth		188	195	245	245
	mm		188	195	245	245
Weight	kg		8.5	11	17	17
System Operation Control		Wireless Control with LCD Display				
Power Supply	V/Ph/Hz		115/1/60		220-230/1/60	
	Ph		1	1	1	1
Compressor	Qty		1	1	1	1
	Compressor Type		Rotary			
Dimension	Height		540	540	695	857
	Width		780	780	845	895
Dimension	Depth		250	250	335	302
	mm		250	250	335	302
Weight	kg		33	36	58	80
Piping	Type		Flare + Nut			
	Pipe Size	Suction	inch	3/8	1/2	1/2
Pipe Size		Liquid	inch	1/4	1/4	1/4

Remark: The above design and specifications are subject to change without prior notice for product improvement.

TECHNICAL SPECIFICATION

Technical Specifications : Eco Ultra R407C - 50 Hz

Models	Indoor	HEEB-HEKB																
	Unit	HEEB07	HEKB07	HEEB09	HEKB09	HEEB12	HEKB12	HEEB18	HEKB18	HEEB21	HEKB21	HEEB24	HEKB24	HEEB30	HEKB30	HEEB30	HEKB30	
	Outdoor	HEDB-HEJB																
Power Supply	V/Ph/Hz	220-240/1/50 or 380-415/3/50																
	Ph	1	1	1	1	1	1	1	1	1	1	1	1	1	1	1	3	
Power Consumption	W	800	1050	1320	1980	2350	2700	3200	3300									
Running Current	A	3.5	4.6	5.8	9.5	10.7	12	15.0	5.8									
Refrigerant Type	R407C																	
Refrigerant Charge		650	740	780	800	780	1100	1380	1380	2200	2100	1850	1900	1800	1850	1850	1900	
Noise level	Indoor	dB(A)																
	Outdoor	35/32/30	36/32/30	40/36/34	42/40/38	41/37/35	43/40/37	45/42/39	45/42/39									
Indoor Unit	Power Supply	V/Ph/Hz	220-240/1/50 or 380-415/3/50															
		Ph	1	1	1	1	1	1	1	1								
	Fan	Air flow (Hi/Mi/Lo)	m ³ /h	430/400/370	470/440/410	500/450/400	800/770/740	1050/950/850	1150/1050/950									
		Input Power	W	37.5	36.5	39.5	38.5	50	53	65/64/62	70/66/63							
		Running Current	A	0.17			0.237	0.26	0.317									
	Dimension	Height	mm	250				286	330									
		Width	mm	750				906	1080									
		Depth	mm	188				235	222									
	Weight	kg	8.5				13.5	17										
	System Operation Control																	
Wireless Control with LCD Display																		
Power Supply	V/Ph/Hz	220-240/1/50 or 380-415/3/50																
	Ph	1	1	1	1	1	1	1	1	1	1	1	1	1	1	1	3	
Compressor	Qty	1	1	1	1	1	1	1	1	1	1	1	1	1	1	1		
	Compressor Type	Rotary											Scroll					
Dimension	Height	mm	535				540	590	695									
	Width	mm	700				780	760	845									
	Depth	mm	235				250	285	335									
Weight	kg	29	30	28	29	34	36	41	41	52	55	61	62	63	64	63	64	
Piping	Type	Flare + Nut																
	Pipe Size	Suction	inch	3/8				1/2				5/8						
	Liquid	inch	1/4				1/4				3/8							

Remark: The above design and specifications are subject to change without prior notice for product improvement.

DECLARATION OF CONFORMITY



DECLARATION OF CONFORMITY

Type of Equipment
Brand Name
Type Designation

Air Conditioners
YORK

HAEA-HADA07/09/12FS, HAEB-HADB07/09/12FS, HAEC-HADC07/09/12FS, HAKA-HAJA07/09/12FS,
HAKB-HAJB07/09/12FS, HAKC-HAJC07/09/12FS, HEEB-HEDB07/09/12/18/24/30FS,
HEKB-HEJB07/09/12/18/21/24/30FS, HLEA-HLDA07/09/12/18/24FS, HLCA-HLHA24/28/FS,
HMEA09MC/MD/ME, HMDA18MC, HMDA21MD, HMDA27ME, HMKB09MC/MD/ME/ME,
HMKB12MD/ME, HMJB18MC, HMJB21MD, HMJB27ME, HMJB30MF, HRKB09AB/AG/AH,
HRKB12AG, HRJB18AB, HRJB21AG, HRJB27AH, HRKA09AB, HRJA18AB,
HSKB-HSJB07/09/12/18/24FS, HTEA-HTDA18/21/24/30FS, HVKA-HVJA09/12/21/24AS,
HVKC-HVJC07/09/12DS, HVKC-HVJC18AS, PECA09/12FD,
PECB09/12/14FS, PESA09/12FD, PESB09/12/14FS, PLCA09FC/FD, PLCB09FC/FD,
PLSA09FC/FD, PLSB09FC/FD
MACC-MAHC07/09/12/18/24FS, MECB-MEHB07/09/12/18/24FS, MLCA-MLHA07/09/12/18/24FS,
MLCB-MLHB07/09/12/18/24FS
EMC Directive 89/336/EEC, Low Voltage Directive 73/23/EEC and Machine Safety Directive: MSD 98/37/CE

Application of Council
Directive (s)

The following harmonized standards have been applied:

Standard (s)

EN 60335-2-40/A1:2000
EN 60335-2-40/A1:2000
EN 55014-1:2000/A2:2002
EN 55014-2:1997/A1:2001
EN 55022:1998/A1:2000
EN 61000-3-2:2000
EN 61000-3-3:1995/A1:2001
EN 61000-3-11:2000
EN 60825
EN 60335-1:1994+A11:1995+A1, A12:1996+A13, A14:1998+A15, A2:2000+A16:2001
EN 60335-2-40:1997+A1:2000
EN 55014-1:1993+A1:1997/A2:1999
EN 55104-2:1997
EN 61000-3-2:1995/A1:1998/A2:1998
EN 61000-3-2:1995/A14:2000
EN 61000-3-3:1995
EN 60335-2-40:2003
EN 50366:2003

The product complies with the harmonized European safety standards and harmonized EMC standards listed above.

We have internal production control system that ensures compliance between the manufacturer products and the technical documentation.

The product is CE mark.

We declare under our sold responsibility that the equipment follows the provisions Of the Directives stated above.

Authorized Representative:

CM Choi
Shipping Manager

YORK International (Northern Asia) Ltd.

15/F., Tower II, World Trade Square, 123 Hoi Bun Road, Kwun Tong, Kowloon, Hong Kong
Telephone: (852) 2331 9286 Fax: (852) 2331 9840
Technical Service Division: Telephone: (852) 2331 9286 Fax: (852) 2304 0068

INSTALLATION, REMOVAL AND DISPOSAL

**This product contains refrigerant under pressure, rotating parts, and electrical connections which may be a danger and cause injury!
All work must only be carried out by competent persons using suitable protective clothing and safety precautions.**



Read the Manual



Risk of electric shock



Unit is remotely controlled and
may start without warning

1. Isolate all sources of electrical supply to the unit including any control system supplies switched by the unit. Ensure that all points of electrical and gas isolation are secured in the OFF position. The supply cables and gas pipework may then be disconnected and removed. For points of connection refer to unit installation instructions.
2. Remove all refrigerant from each system of the unit into a suitable container using a refrigerant reclaim or recovery unit. This refrigerant may then be reused, if appropriate, or returned to the manufacturer for disposal. **Under No circumstances should refrigerant be vented to atmosphere.** Where appropriate, drain the refrigerant oil from each system into a suitable container and dispose of according to local laws and regulations governing disposal of oily wastes.
3. Packaged unit can generally be removed in one piece after disconnection as above. Any fixing down bolts should be removed and then unit lifted from position using the points provided and equipment of adequate lifting capacity. Reference MUST be made to the unit installation instructions for unit weight and correct methods of lifting. Note that any residual or spill refrigerant oil should be mopped up and disposed of as described above.
4. After removal from position the unit parts may be disposed of according to local laws and regulations.



YORK® International Corporation